

Canon

PUB. DIM-0949-000

VIXIA
HF S20

VIXIA
HF S21

VIXIA
HF S200



HD Camcorder
Instruction Manual

English

Caméscope HD
Manuel d'instruction

Français

Videocámara HD
Manual de Instrucciones

Español

NTSC

PictBridge

HDMI

AVCHD

Important Usage Instructions

WARNING!

TO REDUCE THE RISK OF FIRE OR ELECTRIC SHOCK, DO NOT EXPOSE THIS PRODUCT TO RAIN OR MOISTURE.

WARNING!

TO REDUCE THE RISK OF ELECTRIC SHOCK AND TO REDUCE ANNOYING INTERFERENCE, USE THE RECOMMENDED ACCESSORIES ONLY.

COPYRIGHT WARNING:

Unauthorized recording of copyrighted materials may infringe on the rights of copyright owners and be contrary to copyright laws.

HD Camcorder, VIXIA HF S20 A / VIXIA HF S21 A / VIXIA HF S200 A systems

This device complies with Part 15 of the FCC Rules. Operation is subject to the following two conditions: (1) This device may not cause harmful interference, and (2) this device must accept any interference received, including interference that may cause undesired operation.

Note: This equipment has been tested and found to comply with the limits for class B digital device, pursuant to Part 15 of the FCC Rules. These limits are designed to provide reasonable protection against harmful interference in a residential installation. This equipment generates, uses and can radiate radio frequency energy and, if not installed and use in accordance with the instructions, may cause harmful interference to radio communications. However, there is no guarantee that interference will not occur in a particular installation. If this equipment does cause harmful interference to radio or television reception, which can be determined by turning the equipment off and on, the user is encouraged to try to correct the interference by one or more of the following measures:

- Reorient or relocate the receiving antenna.
- Increase the separation between the equipment and receiver.
- Connect the equipment into an outlet on a circuit different from that to which the receiver is connected.
- Consult the dealer or an experienced radio/TV technician for help.

Use of shielded cable is required to comply with class B limits in Subpart B of Part 15 of FCC Rules. Do not make any changes or modifications to the equipment unless otherwise specified in the manual. If such changes or modifications should be made, you could be required to stop operation of the equipment.

Canon U.S.A., Inc.
One Canon Plaza, Lake Success, NY 11042, U.S.A.
Tel No. (516)328-5600

CAUTION:

TO PREVENT ELECTRIC SHOCK, MATCH WIDE BLADE OF PLUG TO WIDE SLOT, FULLY INSERT.

WARNING:

To reduce the risk of electric shock, do not expose this product to dripping or splashing.

The Mains plug is used as the disconnect device. The Mains plug shall remain readily operable to disconnect the plug in case of an accident.

CAUTION:

- Danger of explosion if the wrong type of batteries are attached. Use only the same type of batteries.
- Do not expose batteries or product to excessive heat such as the inside of a car under direct sunlight, fire, etc.

Important Warning



CAUTION:

TO REDUCE THE RISK OF ELECTRIC SHOCK, DO NOT REMOVE COVER (OR BACK). NO USER-SERVICEABLE PARTS INSIDE. REFER SERVICING TO QUALIFIED SERVICE PERSONNEL.



The lightning flash with arrowhead symbol, within an equilateral triangle, is intended to alert the user to the presence of uninsulated "dangerous voltage" within the product's enclosure, that may be of sufficient magnitude to constitute a risk of electric shock to persons.



The exclamation point, within an equilateral triangle, is intended to alert the user to the presence of important operating and maintenance (servicing) instructions in the literature accompanying the product.

IMPORTANT SAFETY INSTRUCTIONS

In these safety instructions the word “product” refers to the Canon HD Camcorder VIXIA HF S20 A / VIXIA HF S21 A / VIXIA HF S200 A and all its accessories.

- 1 Read these instructions.
- 2 Keep these instructions.
- 3 Heed all warnings.
- 4 Follow all instructions.
- 5 Do not use this apparatus near water.
- 6 Clean only with dry cloth.
- 7 Do not install near any heat sources such as radiators, heat registers, stoves, or other apparatus (including amplifiers) that produce heat.
- 8 Do not defeat the safety purpose of the polarized or grounding-type plug. A polarized plug has two blades with one wider than the other. A grounding type plug has two blades and a third grounding prong. The wide blade or the third prong are provided for your safety. If the provided plug does not fit into your outlet, consult an electrician for replacement of the obsolete outlet.
- 9 Protect the power cord from being walked on or pinched particularly at plugs, convenience receptacles, and the point where they exit from the apparatus.
- 10 Only use attachments/accessories specified by the manufacturer.
- 11 Unplug this apparatus during lightning storms or when unused for long periods of time.
- 12 Refer all servicing to qualified service personnel. Servicing is required when the apparatus has been damaged in any way, such as power-supply cord or plug is damaged, liquid has been spilled or objects have fallen into the apparatus, the apparatus has been exposed to rain or moisture, does not operate normally, or has been dropped.
- 13 Read Instructions — All the safety and operating instructions should be read before the product is operated.
- 14 Retain Instructions — The safety and operating instructions should be retained for future reference.
- 15 Heed Warnings — All warnings on the product and in the operating instructions should be adhered to.
- 16 Follow Instructions — All operating and maintenance instructions should be followed.
- 17 Cleaning — Unplug this product from the wall outlet before cleaning. Do not use liquid or aerosol cleaners. The product should be cleaned only as recommended in this manual.
- 18 Accessories — Do not use accessories not recommended in this manual as they may be hazardous.
- 19 Avoid magnetic or electric fields — Do not use the camera close to TV transmitters, portable communication devices or other sources of electric or magnetic radiation. They may cause picture interference, or permanently damage the camera.
- 20 Water and Moisture — Hazard of electric shock — Do not use this product near water or in rainy/moist situations.

- 21 **Placing or Moving** — Do not place on an unstable cart, stand, tripod, bracket or table. The product may fall, causing serious injury to a child or adult, and serious damage to the product. A product and cart combination should be moved with care. Quick stops, excessive force, and uneven surfaces may cause the product and cart combination to overturn.



- 22 **Power Sources** — The CA-570 Compact Power Adapter should be operated only from the type of power source indicated on the marking label. If you are not sure of the type of power supply to your home, consult your product dealer or local power company. Regarding other power sources such as battery power, refer to instructions in this manual.
- 23 **Polarization** — The CA-570 Compact Power Adapter is equipped with a polarized 2-prong plug (a plug having one blade wider than the other). The 2-prong polarized plug will fit into the power outlet only one way. This is a safety feature. If you are unable to insert the plug fully into the outlet, try reversing the plug. If the plug still fails to fit, contact your electrician to replace your obsolete outlet. Do not defeat the safety purpose of the polarized plug.
- 24 **Power Cord Protection** — Power cords should be routed so that they are not likely to be walked on or pinched by items placed upon or against them. Pay particular attention to plugs and the point from which the cords exit the product.

- 25 **Outdoor Antenna Grounding** — If an outside antenna is connected to the product, be sure the antenna is grounded so as to provide some protection against voltage surges and built-up static charges. Section 810 of the National Electrical Code, ANSI / NFPA No. 70—1984, provides information with respect to proper grounding of the mast and supporting structure, grounding of the lead-in wire to an antenna discharge unit, size of grounding conductors, location of antenna discharge unit, connection to grounding electrodes, and requirements for the grounding electrode. See figure 1.

Fig. 1 EXAMPLE OF ANTENNA GROUNDING AS PER NATIONAL ELECTRICAL CODE

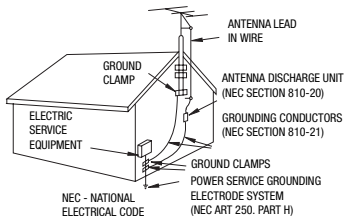

- 26 **Lightning** — For added protection of this product during a lightning storm, or when it is left unattended and unused for long periods of time, disconnect it from the wall outlet and disconnect the antenna. This will prevent damage to the product due to lightning and power-line surges.
- 27 **Overloading** — Do not overload wall outlets and extension cords as this can result in a risk of fire or electric shock.
- 28 **Objects and Liquid Entry** — Never push objects of any kind into this product through openings as they may touch dangerous voltage points or short out parts that could result in a fire or electric shock. Be careful not to spill liquid of any kind onto the product.
- 29 **Servicing** — Do not attempt to service this product yourself as opening or removing covers may expose you to dangerous voltage or other hazards. Refer all servicing to qualified service personnel.

- 30 **Damage Requiring Service** — Disconnect this product from the wall outlet and all power sources including battery, and refer servicing to qualified service personnel under the following conditions:
- When the power-supply cord or plug is damaged.
 - If any liquid has been spilled onto, or objects have fallen into, the product.
 - If the product has been exposed to rain or water.
 - If the product does not operate normally even if you follow the operating instructions. Adjust only those controls that are covered by the operation instructions. Improper adjustment of other controls may result in damage and will often require extensive work by a qualified technician to restore the product to its normal operation.
 - If the product has been dropped or the cabinet has been damaged.
 - When the product exhibits a distinct change in performance. This indicates a need for service.
- 31 **Replacement Parts** — When replacement parts are required, be sure the service technician has used replacement parts that are specified by Canon or that have the same characteristics as the original part. Unauthorized substitutions may result in fire, electric shock or other hazards.
- 32 **Safety Check** — Upon completion of any service or repairs to this product, ask the service technician to perform safety checks to determine that the product is in safe operating order.
- 33 **Heat** — The product should be situated away from heat sources such as radiators, heat registers, stoves, or other products (including amplifiers) that produce heat.

When replacement of the power supply is required, please return it to the responsible nearest Canon Service Center and please replace it with the same type number CA-570.

The Adapter can be used with a power supply between 100 and 240 V AC. For areas where 120 V AC power is not used, you will need a special plug adapter. Contact your nearest Canon Service Center for further information.

This Class B digital apparatus complies with Canadian ICES-003.

The serial number of this product can be found at the battery attachment unit of the camcorder. Write down the number and other information here and retain this book as a permanent record of your purchase to aid identification in case of theft.

Model Name: VIXIA HF S20 A / VIXIA HF S21 A / VIXIA HF S200 A

Date of Purchase: Serial No.:

Purchased From:

Dealer Address:

Dealer Phone No.:

Trademark Acknowledgements

- The SD logo is a trademark. The SDHC logo is a trademark.
- Microsoft and Windows are trademarks or registered trademarks of Microsoft Corporation in the United States and/or other countries.
- Macintosh and Mac OS are trademarks of Apple Inc., registered in the U.S. and other countries.
- “x.v.Color” and the “x.v.Color” logo are trademarks.
- HDMI, the HDMI logo and High-Definition Multimedia Interface are trademarks or registered trademarks of HDMI Licensing LLC.
- “AVCHD” and the “AVCHD” logo are trademarks of Panasonic Corporation and Sony Corporation.
- Manufactured under license from Dolby Laboratories.
“Dolby” and the double-D symbol are trademarks of Dolby Laboratories.
- YouTube is a trademark of Google Inc.
- Other names and products not mentioned above may be trademarks or registered trademarks of their respective companies.
- This device incorporates exFAT technology licensed from Microsoft.
- ANY USE OF THIS PRODUCT OTHER THAN CONSUMER PERSONAL USE IN ANY MANNER THAT COMPLIES WITH THE MPEG-2 STANDARD FOR ENCODING VIDEO INFORMATION FOR PACKAGED MEDIA IS EXPRESSLY PROHIBITED WITHOUT A LICENSE UNDER APPLICABLE PATENTS IN THE MPEG-2 PATENT PORTFOLIO, WHICH LICENSE IS AVAILABLE FROM MPEG LA, L.L.C., 250 STEELE STREET, SUITE 300, DENVER, COLORADO 80206.
- This product is licensed under AT&T patents for the MPEG-4 standard and may be used for encoding MPEG-4 compliant video and/or decoding MPEG-4 compliant video that was encoded only (1) for a personal and non-commercial purpose or (2) by a video provider licensed under the AT&T patents to provide MPEG-4 compliant video. No license is granted or implied for any other use for MPEG-4 standard.



Exciting Features and New Functions



High-Definition Video



Your camcorder's full high-definition image sensor (Full HD CMOS) captures video at a resolution of 1,920 x 1,080 pixels². Videos are then recorded in the memory in high definition, using AVCHD specifications³.

With your new HD camcorder, capturing the special moments in your life with amazing image quality and in lifelike vibrant colors is easy and fun!



HF S21/S20 Dual Flash Memory

You can record in the built-in memory or on commercially available memory cards (📖 36).

Relay Recording



The memory almost full? Use the double memory card slot to keep on recording video without interruption (📖 39).

¹ "Full HD 1080" refers to Canon camcorders compliant with high-definition video composed of 1,080 vertical pixels (scanning lines).

² Video is recorded at this resolution only when the recording mode is set to MXP or FXP mode. In other recording modes, the picture is recorded at 1,440 x 1,080 pixels.

³ AVCHD is a standard for recording high-definition video. With AVCHD specifications, the video signal is recorded using MPEG-4 AVC/H.264 compression and the audio signal is recorded in Dolby Digital.

Smart AUTO Smart AUTO (📖 43)

Smart AUTO automatically selects the best scene mode for the scene you want to shoot. You get spectacular recordings every time without worrying about settings.



Just point the camcorder and it will automatically select the best settings for your subject

Video Snapshot (📖 69)

Shoot or capture short scenes and arrange them into a video clip set to your favorite background music.



Face Detection (📖 67)

The camcorder automatically detects people's faces and adjusts the focus and other settings accordingly for beautiful results.

Image Stabilization



Dynamic IS (📖 64) compensates for camcorder shake when you shoot video while walking. Powered IS (📖 65) will produce stable shots when you zoom in on distant subjects (full telephoto).

Enjoying your Recordings on Other Devices

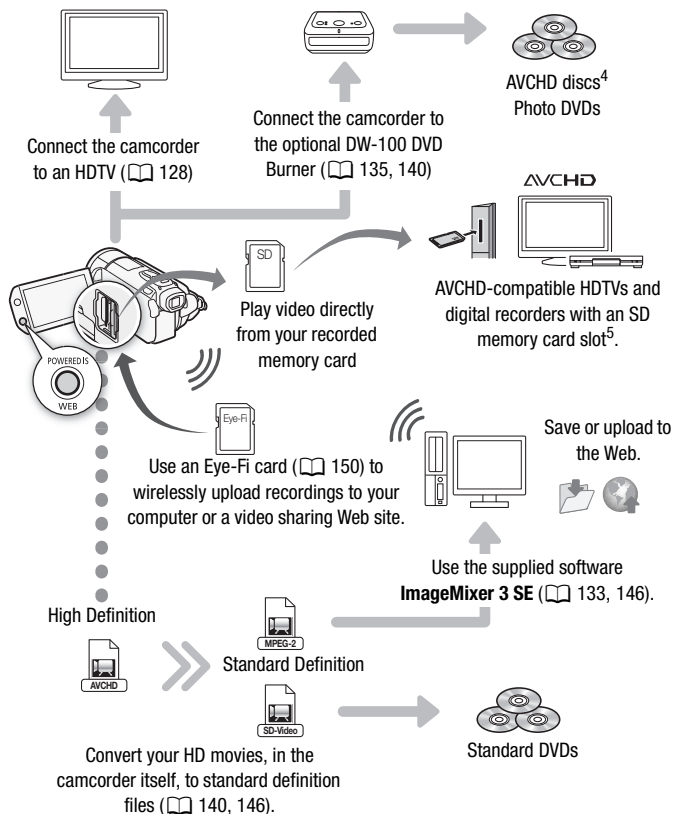

⁴ AVCHD discs containing scenes recorded in MXP mode cannot be created with the optional DW-100 DVD burner. Use the supplied software **ImageMixer 3 SE** to back up such scenes.

⁵ Refer to the instruction manual of the device. Depending on the device used, correct playback may not be possible even if the device is AVCHD-compatible. In such case, play back the recordings on the memory card using the camcorder.

Table of contents

■ Introduction

- 8 Exciting Features and New Functions
- 16 About this Manual
- 18 Getting to Know the Camcorder**
- 18 Supplied Accessories and CD-ROMs
- 19 Names of Parts

■ Preparations

22 Getting Started

- 22 Charging the Battery Pack
- 24 Preparing the Accessories
- 26 Adjusting the LCD Screen and (HFS21 only) Using the Viewfinder

29 Basic Operation of the Camcorder

- 29 Using the Touch Screen
- 30 Operating Modes
- 32 Using the Menus

34 First Time Settings

- 34 Setting the Date and Time
- 35 Changing the Language
- 35 Changing the Time Zone

36 Using a Memory Card

- 36 Memory Cards Compatible for Use with the Camcorder
- 37 Inserting and Removing a Memory Card
- 38 Selecting the Memory for the Recordings
- 39 Relay Recording of Movies
- 40 Initializing the Built-in Memory (HFS21/S20 only) or Memory Card

■ Dual Shot Mode

42 Basic Recording

- 42 Shooting Video and Taking Photos in Dual Shot Mode
- 43 About the Smart AUTO mode
- 46 Zooming
- 47 Quick Start Function

■ Video

49 Basic Playback

- 49 Playing Back the Video
- 53 The Index Selection Screen: Selecting the Content to Play Back
 - 55 3D Flip View
- 56 Narrowing Down the Scenes Shown in the Index Screen
- 57 Deleting Scenes

59 Advanced Functions

- 59 Shooting Video in **M** Manual Mode
- 60 Selecting the Video Quality (Recording Mode)
- 61 Special Scene Recording Programs
- 63 Cinema Mode: Giving a Cinematic Look to your Recordings
- 64 Advanced Image Stabilization
- 66 Pre-Recording
- 67 Face Detection
- 68 Touch & Track
- 69 Video Snapshot
- 70 Digital Effects
- 71 Manually Setting the Shutter Speed or Aperture
- 74 Manual Exposure Adjustment
- 76 Automatic Gain Control (AGC) Limit
- 76 Manual Focus Adjustment
- 79 White Balance
- 80 Digital Tele-Converter
- 81 Image Effects
- 82 Mini Video Light
- 83 Self Timer
- 83 Audio Recording Level

- 85 Using Headphones
- 86 Using the Mini Advanced Shoe
- 87 Using an External Microphone
- 89 Using the Custom Key and Dial
- 90 Using a Zoom Remote Controller
- 91 Selecting the Playback Starting Point
- 93 Playing Back Scenes Set to Background Music
- 97 Onscreen Displays and Data Code
- 98 Playlist and Scene Operations**
- 98 Editing the Playlist: Adding, Deleting, Moving and Playing Back
- 100 Capturing Photos and Video Snapshot Scenes from a Movie
- 102 Dividing Scenes

■ Photos

104 Basic Playback

- 104 Viewing Photos
- 106 Deleting Photos

108 Additional Functions

- 108 Taking Photos in **M** Manual Mode
- 109 Selecting Photo Size and Quality
- 111 Flash
- 113 Drive Mode: Continuous Shooting and Exposure Bracketing
- 114 Taking Photos while Recording Movies (Simultaneous Recording)
- 115 Light Metering Mode
- 116 Slideshow
- 117 Magnifying Photos during Playback
- 117 Rotating Photos
- 118 Histogram Display
- 118 Protecting Photos

121 Printing Photos

- 121 Printing Photos (Direct Print)
- 123 Print Orders

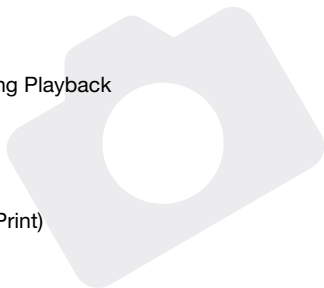

■ External Connections

125 Terminals on the Camcorder

126 Connection Diagrams

128 Playback on a TV Screen

130 Saving and Sharing Your Recordings

130 Copying Recordings to a Memory Card

133 Saving Recordings on a Computer

135 Saving Movies onto High-Definition Discs
(AVCHD/Blu-ray Discs)

140 Saving Movies onto Standard-Definition Discs (DVD)

144 Saving Photos on Photo DVDs

145 Copying Recordings to an External Video Recorder

146 Uploading Movies to Video Sharing Web Sites

■ Additional Information

152 Appendix: Menu Options Lists

152 FUNC. Panel

156 Setup Menus

170 Appendix: Onscreen Icons and Displays

175 Trouble?

175 Troubleshooting

183 List of Messages

194 Do's and Don'ts

194 Handling Precautions

199 Maintenance/Others

200 Using the Camcorder Abroad

201 General Information

201 Accessories

202 Optional Accessories

208 Product Codes





209 Specifications

213 Index

About this Manual

Thank you for purchasing the Canon VIXIA HF S21 / VIXIA HF S20 / VIXIA HF S200. Please read this manual carefully before you use the camcorder and retain it for future reference. Should your camcorder fail to operate correctly, refer to *Troubleshooting* (📖 175).

Conventions Used in this Manual



-  **IMPORTANT:** Precautions related to the camcorder's operation.
-  **NOTES:** Additional topics that complement the basic operating procedures.
-  **POINTS TO CHECK:** Restrictions or requirements regarding the function described.
-  Reference page number within this manual.

To complete some operations you will need to refer also to other instruction manuals. This will be indicated with the following icons:

 Refer to the 'Photo Applications' Instruction Manual, included as a PDF file in the supplied Camcorder Supplemental Disc.

 Refer to the instruction manual of the optional DW-100 DVD Burner.

- **HFS21/S20**: Text that applies only to the model(s) shown in the icon.
- The following terms are used in this manual:
 - When not specified as “memory card” or “built-in memory”, the term “memory” by itself refers to both.
 - “Screen” refers to the LCD and the viewfinder screen (**HFS21** only).
 - “Scene” refers to one movie unit from the point you press the  button to start recording until you press again to pause the recording.
- The photos included in this manual are simulated pictures taken with a still camera. Unless indicated otherwise, illustrations and menu icons refer to the **HFS21**.

 indicates that a function is available in the operating mode indicated and  indicates that the function is not available. For a detailed explanation refer to *Operating Modes* (□ 30).

Brackets [] are used to refer to control buttons and menu options you will touch on the screen and to other onscreen messages and displays.

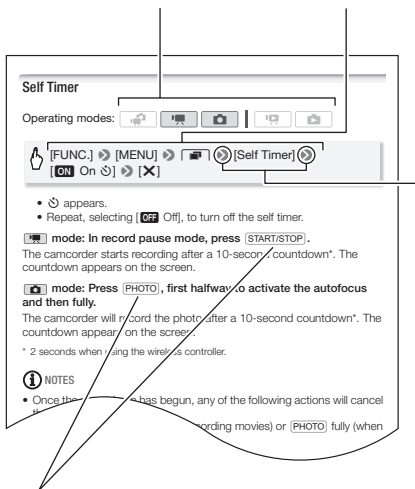

The names of physical buttons and switches on the camcorder are indicated within a “button” frame. For example .

The  arrow is used to abbreviate menu selections. For a detailed explanation on how to use the menus, refer to *Using the Menus* (□ 32). For a concise summary of all available menu options and settings, refer to the appendix *Menu Options Lists* (□ 152).

Supplied Accessories and CD-ROMs

The following accessories are supplied with the camcorder:

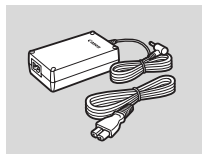

▶ CA-570 Compact Power Adapter
(incl. power cord)

BP-808 Battery Pack ◀



▶ WL-D89 Wireless Controller
(incl. CR2025 lithium button battery)

STV-250N Stereo Video Cable ◀
Yellow • Red • White plugs

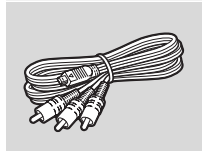
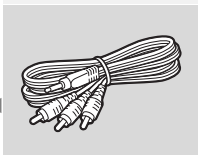

▶ CTC-100/S Component Cable
Red • Green • Blue plugs

IFC-300PCU USB Cable ◀

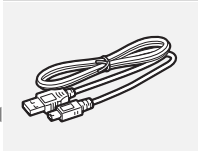

The following CD-ROMs and software are supplied with the camcorder:

- **PIXELA Application - Disc 1 CD-ROM*** and 'PIXELA Applications' Installation Guide
 - ImageMixer 3 SE Transfer Utilities – Software for saving and transferring movies and music files you can use as background music.
- **PIXELA Application - Disc 2 CD-ROM***
 - ImageMixer 3 SE Video Tools – Software for managing, editing, and playing back movies.
- **Photo Applications Ver.34.0*/Music Data Disc CD-ROM** (referred in the manual as the Camcorder Supplemental Disc). Contains the following components.
 - Photo Application - Software for saving, managing, and printing photos*.
 - Music files that can be used as background music during playback**.

* The CD-ROM includes the instruction manual of the software (on PDF file).

These music files are for exclusive use with the supplied software **ImageMixer 3 SE. The disc cannot be played back on CD players. For more details, refer to 'ImageMixer 3 SE Software Guide' (PDF file).

Names of Parts

Left side view

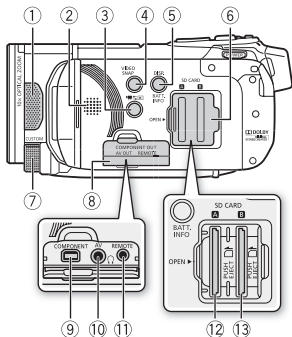

Right side view

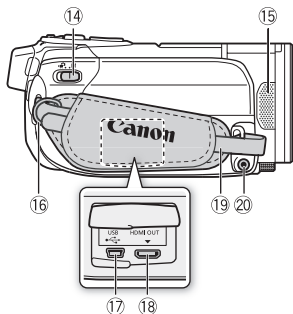

Front view

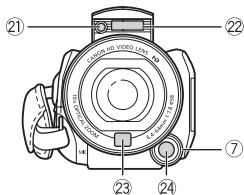

- ① Stereo microphone (L) (83)
- ② Speaker (51)
- ③ (camera/play) button (31)
- ④ VIDEO SNAP (video snapshot) button (69)
- ⑤ DISP. (onscreen display) button (97)/
BATT. INFO button (174)
- ⑥ Double memory card slot cover
- ⑦ CUSTOM dial (89)
- ⑧ Terminal cover
- ⑨ COMPONENT OUT terminal (125, 127)
- ⑩ AV OUT terminal (125, 127)/
⌂ (headphones) terminal (85)
- ⑪ REMOTE (zoom remote controller) terminal (90)
- ⑫ Memory card slot **A** (37)
- ⑬ Memory card slot **B** (37)
- ⑭ Mode switch (30)
- ⑮ Stereo microphone (R) (83)
- ⑯ Strap mount (25)
- ⑰ USB terminal (125, 128)
- ⑱ HDMI OUT terminal (125, 126)
- ⑲ Grip belt (25)
- ⑳ MIC terminal (88)
- ㉑ Mini video light (82)
- ㉒ Flash (111)
- ㉓ Instant AF sensor (157)
- ㉔ CUSTOM button (89)

Top view

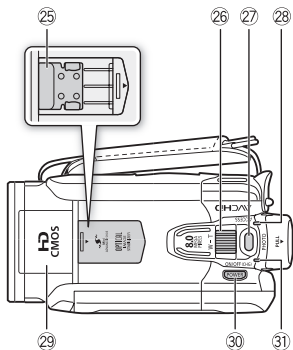

- 25 Mini advanced shoe (86)
- 26 Zoom lever (46)
- 27 PHOTO button (42, 108)
- 28 ACCESS indicator (42, 59, 108)
- 29 Pop-up flash (111) and mini video light (82)
- 30 POWER button
- 31 ON/OFF (CHG) (charge) indicator:
Green – ON
Orange – Standby (47)
Red – Charging (22)
- 32 Remote sensor (25)
- 33 LCD touch screen (26, 29)
- 34 POWERED IS button (65)/
WEB button (146)
- 35 DC IN terminal (22)
- 36 Viewfinder* (28)
- 37 START/STOP button (42, 59)

LCD panel

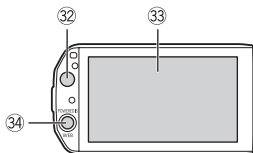

38 Serial number

The serial number label is located inside the battery attachment unit. Remove the battery pack to find it.

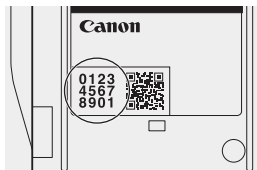

Back view

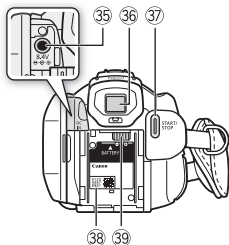

- 39 Battery attachment unit (22)

* **HFS21** only.

Bottom view

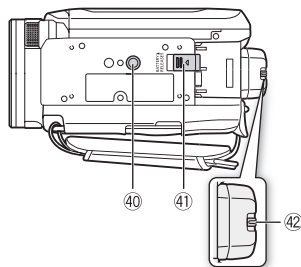

- ④ Tripod socket (195)
 - ④ BATTERY RELEASE switch (23)
 - ④ Dioptic adjustment lever* (28)
- * **HFS21** only.

Wireless Controller WL-D89

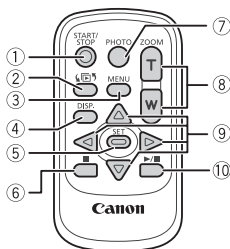

- ① START/STOP button (42, 59)
- ② (index selection) button (53)
Press and hold for more than 2 seconds to switch between shooting and playback mode.
- ③ MENU button (33, 156)
- ④ DISP. (onscreen display) button (97)
- ⑤ SET button
- ⑥ (stop) button (49)
- ⑦ PHOTO button (42, 108)
- ⑧ Zoom buttons (46)
- ⑨ Navigation buttons (/ / /)
- ⑩ (play/pause) button (49)



Preparations

This chapter describes basic operations, such as using the touch panel, navigating the menus, and first time settings to help you learn more about your camcorder.

Getting Started

Charging the Battery Pack

The camcorder can be powered with a battery pack or directly using the compact power adapter. The first time you use a battery pack, fully charge it and then use the camcorder until the battery pack is completely exhausted. Doing so will ensure that the remaining recording time will be displayed accurately.

For approximate charging times and recording/playback times with a fully charged battery pack, refer to *Charging, Recording and Playback Times* (📖 203).

- 1 Connect the power cord to the compact power adapter.
- 2 Plug the power cord into a power outlet.
- 3 Connect the compact power adapter to the camcorder's DC IN terminal.
- 4 Attach the battery pack to the camcorder.

Press the battery pack softly into the battery attachment unit and slide it up until it clicks in place.

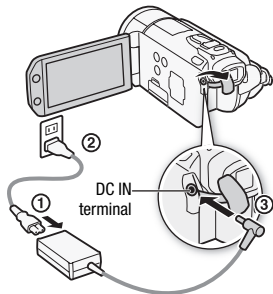

5 Charging will start when the camcorder is turned off.

- If the camcorder was on, the green ON/OFF (CHG) indicator will go out when you turn off the camcorder. After a moment, the ON/OFF (CHG) indicator will start flashing in red (battery pack charging). The red ON/OFF (CHG) indicator will go out when the battery pack is fully charged.
- If the indicator flashes quickly, refer to *Troubleshooting* (📖 175).

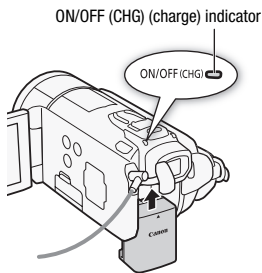

To remove the battery pack

- 1 Slide **BATTERY RELEASE** in the direction of the arrow and hold it pressed down.
- 2 Slide the battery pack in the direction of the arrow and then pull it out.

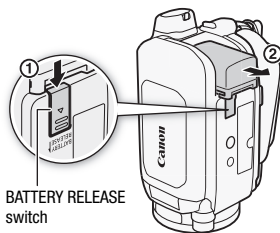

! IMPORTANT

- Turn off the camcorder before connecting or disconnecting the compact power adapter. After pressing **POWER** to turn off the camcorder, important data is updated in the memory. Be sure to wait until the green ON/OFF (CHG) indicator goes out.
- We recommend charging the battery pack in temperatures between 10 °C and 30 °C (50 °F and 86 °F). Outside the temperature range of 0 °C to 40 °C (32 °F to 104 °F), charging will not start.
- Do not connect to the camcorder's DC IN terminal or to the compact power adapter any electrical equipment that is not expressly recommended for use with this camcorder.

- To prevent equipment breakdowns and excessive heating, do not connect the supplied compact power adapter to voltage converters for overseas travels or special power sources such as those on aircraft and ships, DC-AC inverters, etc.

i NOTES

- The battery pack will be charged only when the camcorder is off.
- If remaining battery time is an issue, you can power the camcorder using the compact power adapter so the battery pack will not be consumed.
- Charged battery packs continue to discharge naturally. Therefore, charge them on the day of use, or the day before, to ensure a full charge.
- We recommend that you prepare battery packs to last 2 to 3 times longer than you think you might need.
- **USA and Canada only:** The Lithium ion/polymer battery that powers the product is recyclable. Please call 1-800-8-BATTERY for information on how to recycle this battery.



Preparing the Accessories

Wireless Controller

First, insert the supplied CR2025 lithium button battery into the wireless controller.

- 1 Press the tab in the direction of the arrow and pull out the battery holder.
- 2 Place the lithium button battery with the + side facing up.
- 3 Insert the battery holder.

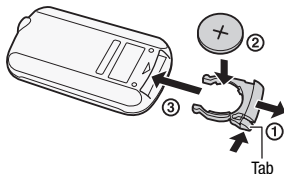

To use the wireless controller

Point the wireless controller at the camcorder's remote sensor when you press the buttons.

You can rotate the LCD panel 180 degrees to use the wireless controller from the front of the camcorder.

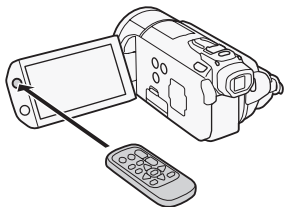

i NOTES

- The wireless controller may not work properly when the remote sensor is situated under strong light sources or direct sunlight.

Grip Belt and Straps

Fasten the grip belt.

Adjust the grip belt so that you can reach the zoom lever with your index finger, and the **START/STOP** button with your thumb.

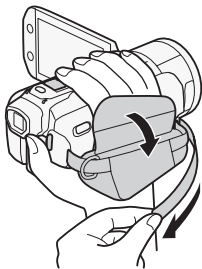

To attach an optional shoulder strap

Pass the ends of the shoulder strap through the strap mount on the grip belt and adjust the length of the strap.

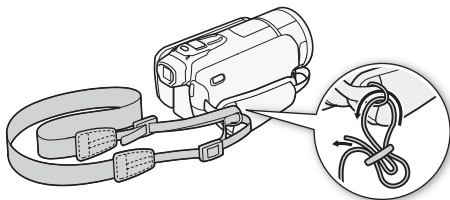

Adjusting the LCD Screen and (HFS21 only) Using the Viewfinder

Rotating the LCD Panel

Open the LCD panel 90 degrees.

- You can rotate the panel 90 degrees downward.
- You can rotate the panel 180 degrees toward the lens. Rotating the LCD panel 180 degrees can be useful in the following cases:
 - **HFS21** To allow the subject to monitor the LCD screen while you use the viewfinder.
 - To include yourself in the picture when recording with the self timer.
 - To allow the camcorder to be operated with the wireless controller from the front.

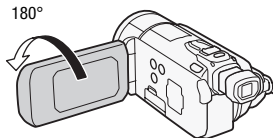
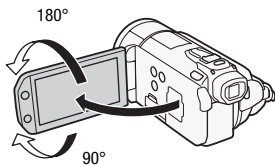

Subject can monitor the LCD screen
(**HFS21** You can use the viewfinder
at the same time)

NOTES

- **About the LCD and viewfinder* screens:** The screens are produced using extremely high-precision manufacturing techniques, with more than 99.99% of the pixels operating to specification. Less than 0.01% of the pixels may occasionally misfire or appear as black, red, blue or green dots. This has no effect on the recorded image and does not constitute a malfunction.

* **HFS21** only.

LCD Backlight



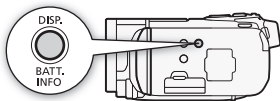

When recording in bright places it may be difficult to use the LCD screen. Turn on the LCD backlight to make it brighter.



With the camcorder on, hold **DISP.** pressed down for more than 2 seconds.

Repeat this action to switch the LCD backlight between off (normal) and on (bright). **HFS21** This changes the brightness of both the LCD and viewfinder screen.

NOTES

- The LCD backlight does not affect the brightness of the recordings.
- Using the bright setting will shorten the effective usage time of the battery pack.
- You can further adjust the brightness of the LCD screen with the   [LCD Brightness] setting, or dim it with the   [LCD Screen Dimmer] setting to use in places where the light from the LCD screen can be a nuisance.

HFS21 Using the Viewfinder

If it is difficult to use the LCD screen even after turning on the LCD backlight, you can use the viewfinder. You can also use the viewfinder when you rotate the LCD panel 180° to let the subject watch the recording.

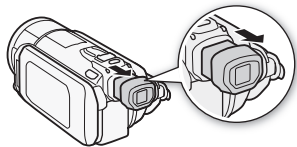

To use the viewfinder, hold out both sides of the viewfinder firmly and pull it out until it clicks.

- You can close the LCD panel or rotate it toward the subject as you prefer.
- Adjust the viewfinder as necessary with the dioptic adjustment lever.
- The LCD backlight setting is common to the LCD screen and the viewfinder.

i NOTES

- **HFS21** For details about how to take care of the viewfinder, refer to *Handling Precautions* (📖 194), *Cleaning* (📖 199).

Basic Operation of the Camcorder

Using the Touch Screen

The control buttons and menu items that appear on the touch screen change dynamically depending on the operating mode and the task you are performing. With the intuitive touch screen interface you have all the controls at your fingertips.

Touch

Touch a menu item to select it, or a control button to perform the corresponding action. For some functions, such as Touch & Track (📖 68) and face detection (📖 67), you can touch a subject that appears on the touch screen to select it and have the camcorder choose the optimal settings.

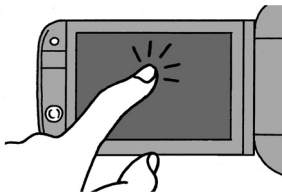

Drag

Swipe your finger up and down or left and right across the screen to scroll menus, to browse through index screen pages or to adjust slider controls (for example, to adjust the volume).

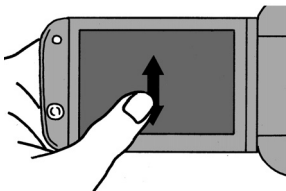

! IMPORTANT











- The camcorder uses a pressure-sensitive touch screen. Press firmly when using touch operations.
- In the following cases, you may not be able to perform touch operations correctly.
 - Operating the touch screen with wet or gloved hands or using your fingernails or other hard-tipped objects such as ballpoint pens.
 - Applying excessive force or forcefully scratching the touch screen.
 - Attaching commercially available screen protectors or adhesive film onto the touch screen's surface.

- For details about how to take care of the touch screen, refer to *Handling Precautions* (📖 194), *Cleaning* (📖 199).

Operating Modes

Recording

When recording video or photos, the camcorder's operating mode is determined by the position of the mode switch and the onscreen control buttons.

Operating mode	Mode switch	Onscreen icon	Operation
Dual Shot	Record video and take photos easily, letting the camcorder take care of all the settings – Great for beginners or if you just prefer not to bother with detailed camcorder settings.		
			Easy recording of movies and photos (📖 42).
Flexible recording	Use one of the dedicated recording modes to enjoy full access to the menus and advanced functions and change the camcorder's settings to your preference.		
			Touch [] to record movies (📖 59).
			Touch [] to record photos (📖 108).







* The mode icon displayed will change according to the optimal mode selected by the Smart AUTO function (📖 43).

Playback

Press the camera/play button  to switch the camcorder between camera (recording) mode and playback mode. The playback mode you switch into depends on the initial recording mode.



You can press  when the camcorder is off to turn it on directly in playback mode.

Initial mode	Operating mode	Operation
Press  in  or  mode.		Playing back movies ([Original] index screen) (📖 49).
Press  in  mode.		Viewing photos ([Photos] index screen) (📖 104).

NOTES

- When switching to a playback mode, the memory selected for playback will be the same currently used for recording.
- You can also press and hold  on the wireless controller for more than 2 seconds to switch between recording and playback mode.



Using the Menu

Many of the camcorder's functions can be adjusted from the FUNC. panel and the setup menus. In  mode, however, menus cannot be accessed and, except in a few cases, most menu settings will return to their default values.

For details about the available menu options and settings, refer to the appendix *Menu Options Lists* (📖 152).

Operating modes:    |  



The FUNC. Panel and Edit Panel

In  and  mode, the FUNC. panel shows a convenient overview of frequently used shooting functions. Touch [FUNC.] to access the FUNC. panel and then touch the function you want to set or adjust. You may need to drag your finger up and down along the scroll bar to find the control button of the desired function.

Touch the control button of the desired function



Drag your finger up and down along the scroll bar to display the rest of the panel



In  and  mode, touch [Edit] to display a similar panel containing the various operations that are available after selecting one or more scenes or photos (for example, deleting, adding scenes to the playlist, protecting photos, etc.). Touch the control button of the desired operation.

Example of the Edit panel in  mode

Touch the control button of the desired operation



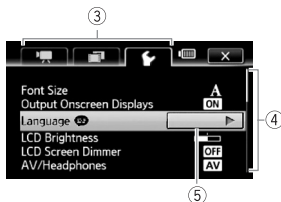

The Setup Menu

- 1  or  mode only: Touch [FUNC.]
- 2 Touch [MENU] to open the setup menus.
You can also press [MENU] on the wireless controller to open the setup menus.



- 3 Touch the tab of the desired menu.
- 4 Drag your finger up and down along the scroll bar to bring the setting you want to change into the orange selection bar.
Menu items not available appear grayed out.
- 5 When the desired menu item is in the orange bar, touch inside the frame on the right.
- 6 Touch the desired option and touch [X].
You can touch [X] to close the menu at any time.

NOTES

- A small font size is used in menu screens so you can see the options currently selected. You can enlarge the font size by setting   [Font Size] to [A Large] but only the icons of the currently selected options will appear on the screen.

First Time Settings

Setting the Date and Time

You will need to set the date and time of the camcorder before you can start using it. The [Date/Time] screen will appear automatically when the camcorder's clock is not set.

When the [Date/Time] screen appears, the year will be selected.



- 1 Touch a field you want to change (year, month, day, hours or minutes).
- 2 Touch [▲] or [▼] to change the field as necessary.
- 3 Set the correct date and time by changing all the fields in the same way.
- 4 Touch [Y.M.D], [M.D.Y] or [D.M.Y] to select the date format you prefer.
- 5 Touch [24H] to use 24-hour clock or leave this control unchecked to use 12-hour clock (AM/PM).
- 6 Touch [OK] to start the clock and close the setup screen.

NOTES

- When you do not use the camcorder for about 3 months, the built-in rechargeable lithium battery may discharge completely and the date and time setting may be lost. In such case, recharge the built-in lithium battery (197) and set the time zone, date and time again.
- To change the date and time later on (not during the initial setup), open the [Date/Time] screen from the setup menus:



[FUNC.]* ➤ [MENU] ➤  ➤ [Date/Time]

* Only when performing the procedure in a recording mode.

Changing the Language

The default language of the camcorder is English. You can set it to one of 22 other languages.

Operating modes:    |  

 [FUNC.]*  [MENU]    [Language 
Desired language  [OK]  [X]

* Only when performing the procedure in a recording mode.

NOTES

- Some control buttons, such as [ZOOM], [FUNC.] or [MENU], will appear in English regardless of the language selected.

Changing the Time Zone



Change the time zone to match your location. The default setting is New York.

Operating modes:    |  

- 1 Open the [Time Zone/DST] screen.



 [FUNC.]*  [MENU]    [Time Zone/DST]

* Only when performing the procedure in a recording mode.



- 2 Touch [- 3 Touch [- 4 Touch [

Using a Memory Card

Memory Cards Compatible for Use with the Camcorder

You can use commercially available  SDHC (SD high capacity) memory cards and  SD memory cards with this camcorder. However, depending on the memory card, you may not be able to record movies. Refer to the table below.

As of October 2009, the movie recording function has been tested using SD/SDHC memory cards made by Panasonic, Toshiba and SanDisk.

Memory card	Capacity	SD Speed Class	Recording movies
 SD memory cards	64 MB or less	–	–
	128 MB or more	–	●*
		CLASS② CLASS④ CLASS⑥ CLASS⑩	●
 SDHC memory cards	Over 2 GB	CLASS② CLASS④ CLASS⑥ CLASS⑩	●

* Depending on the memory card used, it may not be possible to record movies.

About the SD Speed Class:

The SD Speed Class is a standard that indicates the minimum guaranteed data transfer speed of SD/SDHC memory cards. When you buy a new memory card, look for the Speed Class logo on the package. We recommend using memory cards rated Speed Class 4, 6 or 10.

Eye-Fi Cards

This product is not guaranteed to support Eye-Fi card functions (including wireless transfer). In case of an issue with an Eye-Fi card, please check with the card manufacturer.

Also note that an approval is required to use Eye-Fi cards in many countries or regions. Without approval, use of the card is not permitted. If it is unclear whether the card has been approved for use in the area, please check with the card manufacturer.

Inserting and Removing a Memory Card

Make sure to initialize (📖 40) all memory cards before using them with this camcorder.

1 Turn off the camcorder.

Make sure the ON/OFF (CHG) indicator is off.

2 Open the double memory card slot cover.

3 Insert the memory card into one of the memory card slots.

- You can also use two memory cards, one in each memory card slot.
- Insert the memory card straight, with the label facing the front of the camcorder, all the way into the memory card slot until it clicks.
- To use the wireless communication features of an Eye-Fi card, insert it into memory card slot **B**. Be sure you understand the information provided in *Eye-Fi Cards* (📖 36) before using an Eye-Fi card.

4 Close the double memory card slot cover.

Do not force the cover closed if the memory card is not correctly inserted.

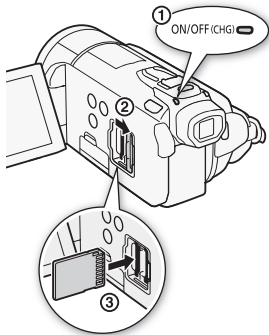

To remove the memory card

Push the memory card once to release it. When the memory card springs out, pull it all the way out.

! IMPORTANT

- Memory cards have front and back sides that are not interchangeable. Inserting a memory card facing the wrong direction can cause a malfunction of the camcorder. Be sure to insert the memory card as described in step 3.

Selecting the Memory for the Recordings



You can select to record your movies and photos in the built-in memory or on a memory card. The default memory for recording both is the built-in memory (**HFS21/S20**) or memory card **A** (**HFS200**).

Operating modes:    |  



POINTS TO CHECK

- Be sure you understand the information provided in *Eye-Fi Cards* (📖 36) before using an Eye-Fi card.

HFS21/S20

 [FUNC.] ➤ [MENU] ➤  ➤
[Rec Media for Movies] or [Rec Media for Photos] ➤
[] (built-in memory), [**A**] (memory card **A**) or [**B**]
(memory card **B**)* ➤ [**X**]

HFS200

 [FUNC.] ➤ [MENU] ➤  ➤
[Rec Media for Movies] or [Rec Media for Photos] ➤
[**A**] (memory card **A**) or [**B**] (memory card **B**)* ➤ [**X**]

* When selecting the memory, you can check the approximate available recording time/number of photos, based on currently used settings.

NOTES

- Select to record movies in the built-in memory (**HFS21/S20** only) or memory card **A** if you later want to convert the movies to standard definition in order to upload them to the Web or to create standard DVDs.

Relay Recording of Movies

You can activate the relay recording so if the memory you are using becomes full while recording movies, the recording will continue uninterrupted on a memory card.



When recording on memory card **A**, you can use memory card **B** for relay recording (**A** → **B**). **HFS21/S20** only: When recording in the built-in memory, you can choose to use only memory card **A** for relay recording (**☑** **A**), or use both memory cards (**☑** **A** → **B**).

Operating modes:    |  

1 Insert a memory card that contains no video recordings into the card slot of the memory card you want to use for relay recording.

- When relay recording from the built-in memory (**HFS21/S20** only): memory card slot **A** or both memory card slots.
- When relay recording from memory card **A**: memory card slot **B** only.

2 Activate the relay recording.

 [FUNC.] ➤ [MENU] ➤  ➤ [Rec Media for Movies] ➤
[] (**HFS21/S20** only) or [**A**] ➤ [Relay Recording]
➤ Desired option* ➤ [**X**]

* The approximate available recording time will now reflect the combined space in the memories used for relay recording.

NOTES

- **HFS21/S20** You cannot use relay recording from the built-in memory to memory card **B**. When using a single memory card, be sure to insert it into memory card slot **A**.
- Any of the following actions will deactivate the relay recording function:
 - Turning off the camcorder.
 - Opening the double memory card slot cover.
 - Changing the position of the mode switch.
 - Changing the camcorder's operating mode.
 - Changing the memory used for recording movies.

Initializing the Built-in Memory (HFS21/S20 only) or Memory Card

Initialize memory cards when you use them with this camcorder for the first time. You can also initialize a memory card or the built-in memory (HFS21/S20 only) to permanently delete all the recordings it contains.

HFS21/S20 At the time of purchase, the built-in memory comes pre-initialized and contains music files for use as background music during playback.







Operating modes:    |  

1 Power the camcorder using the compact power adapter.





Do not disconnect the power source or turn off the camcorder until the initialization is completed.

2 Initialize the memory.

HFS21/S20

 [FUNC.]* ➤ [MENU] ➤  ➤ [Initialize / ] ➤
[ Built-in Mem.], [ Mem. Card A] or [ Mem. Card B]
➤ [Initialize] ➤ [Complete Initialization]* ➤ [Yes]** ➤ [OK]
➤ [X]

HFS200

 [FUNC.]* ➤ [MENU] ➤  ➤ [Initialize ] ➤
[ Mem. Card A] or [ Mem. Card B] ➤ [Initialize] ➤
[Complete Initialization]* ➤ [Yes]** ➤ [OK] ➤ [X]

* Touch this option if you want to physically erase all the data rather than just clear the file allocation table of the memory.

**If you selected the [Complete Initialization] option, you can touch [Cancel] to cancel the initialization while it is in progress. All recordings will be erased and the memory can be used without any problem.

IMPORTANT

- Initializing the memory will permanently erase all recordings. Lost original recordings cannot be recovered. Make sure you save important recordings in advance using an external device (📖 130).
- Initializing a memory card will permanently erase any music files you may have transferred to the card. (**HFS21/S20** The music files that come pre-installed in the built-in memory will be restored after it is initialized.)
 - Windows users: Use the supplied software **ImageMixer 3 SE** to transfer music files from the supplied Camcorder Supplemental Disc to a memory card after it is initialized. For details, refer to the 'ImageMixer 3 SE Software Guide' (PDF file).
 - Mac OS users: Use Finder to transfer music files from the [MUSIC] folder on the supplied Camcorder Supplemental Disc to a memory card after it is initialized. Refer to *About the music files* (📖 212) for the folder structure of the memory card.
- At the time of purchase, Eye-Fi cards contain the necessary network configuration software. Be sure to install the software and complete the required configuration setup before you initialize the Eye-Fi card prior to using it with this camcorder.
- **HFS21/S20** Initializing the built-in memory using the [Complete Initialization] option can take some time (about 1.5 hours).



Dual Shot Mode

This chapter covers how to easily record video and photos in the all-automatic Dual Shot mode, and how to use basic shooting functions like zoom and Quick Start. To enjoy full access to menus and more advanced functions, refer to the relevant chapters for video (📖 59) and photos (📖 108).

Basic Recording

Shooting Video and Taking Photos in Dual Shot Mode

Operating modes:    |  

1 Set the mode switch to .

2 Turn on the camcorder.

- By default, movies and photos are recorded in the built-in memory (HFS21/S20 only) or on memory card **A** (HFS200). You can select the memory that will be used to record movies and photos (📖 38).
- Please read the IMPORTANT section (📖 44) before using an Eye-Fi card.

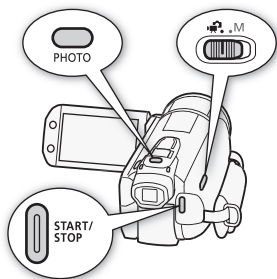

To record video

Press **START/STOP** to begin recording.

Press **START/STOP** again to pause the recording.

To take photos

1 Press **PHOTO** halfway.

Once the focus is automatically adjusted,  will turn green and one or more AF frames will appear.







2 Press **PHOTO** fully.

The ACCESS indicator will flash as the photo is being recorded.

When you have finished recording

- 1 Make sure that the ACCESS indicator is off.
- 2 Turn off the camcorder.
- 3 Close the LCD panel.

























About Dual Shot

- Only the following functions are available in  mode.
 - Zoom ( 46).
 - Quick Start ( 47).
 - Video snapshot ( 69).
 - Advanced image stabilization modes ( 64) to shoot video while walking or to stabilize the shot while zooming in on faraway subjects (telephoto).
 - Face detection ( 67) to get beautiful shots of people every time, tracking the subject even if the person moves.
 - Touch & Track ( 68) to track other moving subjects, keeping them in focus and using the best settings to record them.







About the Smart AUTO mode

When shooting in  mode, the camcorder will automatically detect certain characteristics of the subject, background, lighting conditions, etc. It will then adjust various settings (focus, exposure, color, image stabilization, image quality, among others), selecting the best settings for the scene you want to shoot. The Smart AUTO mode icon will change to one of the following icons.

Smart AUTO icons

Background → (color of the icon)	Bright (grey)	Blue skies (light blue)	Vivid colors (green/red)	Sunsets (orange)
Subject ↓				
People (stationary)	 ()	 ()	 ()	—
People (moving)	 ()	 ()	 ()	—
Subjects other than people, such as landscapes	 ()	 ()	 ()	
Close objects	 ()	 ()	 ()	—

The icon in parentheses appears under backlight conditions.











Background → (color of the icon)	Dark (dark blue)		
Subject ↓	Spotlight	Night scene	
People (stationary)		—	—
People (moving)		—	—
Subjects other than people, such as landscapes			
Close objects		—	—

IMPORTANT

- Observe the following precautions while the ACCESS indicator is on or flashing. Failing to do so may result in permanent data loss or damage to the memory.
 - Do not open the double memory card slot cover.
 - Do not disconnect the power source or turn off the camcorder.
 - Do not change the camcorder's operating mode.

- Be sure to save your recordings regularly (📖 130), especially after making important recordings. Canon shall not be liable for any loss or corruption of data.
- When recording photos on an Eye-Fi card in memory card slot **B**, photos will be uploaded automatically if you are within the range of a configured network. Always verify that Eye-Fi cards have been approved in the country/region of use. See also *Using an Eye-Fi card* (📖 150).



NOTES

- **About the Power Save mode:** If  ➤ [Power Saving Mode] ➤ [Auto Power Off] is set to [ON On], the camcorder will shut off automatically to save power when it is powered by a battery pack and is left without any operation for 5 minutes. Press **POWER** to turn on the camcorder.
- When recording in bright places, it may be difficult to use the LCD screen. In such cases, you can turn on the LCD backlight (📖 27) or adjust the brightness of the LCD screen with the  ➤ [LCD Brightness] setting. **HFS21** You can also use the viewfinder (📖 28).
- **When taking photos:**
 - If the subject is not suitable for autofocus,  turns yellow. Set the camcorder to  mode and adjust the focus manually (📖 76).
 - When the subject is too bright, [Overexp.] will flash on the screen. In such case, use the optional 58 mm ND4-L or ND8-L filter.
- Under certain conditions, the Smart AUTO icon that appears on the screen may not match the actual scene. Especially when shooting against orange or blue backgrounds, the Sunset or one of the Blue Skies icons may appear and the colors may not look natural. In such case, we recommend recording in **M** manual mode (📖 59, 108).
- In  mode, menus cannot be accessed but the following settings can be changed in advance, before setting the mode switch to .
 - / menu: [AF mode], [Auto Slow Shutter], [POWERED IS Button].
 -  menu: [Video Snapshot Length], [Rec Media for Movies], [Recording Mode], [Rec Media for Photos], [Photo Size/Quality], [Simultaneous Recording].
 -  menu: All settings.

Zooming

Operating modes:    |  

There are three ways you can zoom in and out: using the zoom lever on the camcorder, using the zoom buttons on the wireless controller or using the zoom controls on the touch screen.

In addition to the 10x optical zoom, in  mode, you can turn on the 200x digital zoom with the  ➤ [Digital Zoom] setting.

Using the Zoom Lever or Wireless Controller

Move the zoom lever toward **W** (wide angle) to zoom out. Move it toward **T** (telephoto) to zoom in.

- By default, the zoom lever operates at a variable speed – press gently for a slow zoom; press harder for faster zooms.
- You can also use the zoom buttons on the wireless controller.

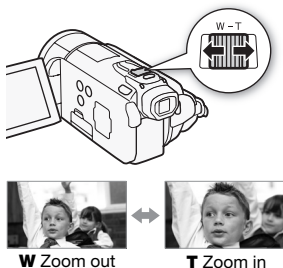

Using the Touch Screen's Zoom Controls

1 Display the zoom controls on the touch screen.

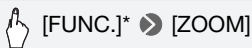

* Not necessary in  mode.

- The zoom controls appear on the left side of the screen.







2 Touch the zoom controls to operate the zoom.

Touch anywhere within the **W** area to zoom out or anywhere within the **T** area to zoom in. Touch closer to the center for a slow zoom; touch closer to the **W/T** icons for faster zooms.



3 Touch [X] to hide the zoom controls.

NOTES

- Keep at least 1 m (3.3 ft.) away from the subject. At full wide angle, you can focus on a subject as close as 1 cm (0.39 in.).
- In  or  mode, you can also set /  [Zoom Speed] to one of three constant speeds (3 is the fastest, 1 the slowest).
- When [Zoom Speed] is set to [VAR Variable]:
 - When you use the **T** and **W** buttons on the wireless controller, the zoom speed will be constant at  Speed 3].
 - The zoom speed will be faster in record pause mode than when actually recording, except when pre-recording ( 66) is activated.

Quick Start Function

When you close the LCD panel with the camcorder on, the camcorder enters the standby mode. In standby mode the camcorder consumes only about 1/3 the power used when recording, saving energy when you are using a battery pack. Additionally, when you open the LCD panel or pull out the viewfinder (**HFS21** only), the camcorder is ready to start recording in approximately 1 second*, allowing you to record the subject right away.

* The actual time required varies depending on the shooting conditions.

Operating modes:    |  

1 With the camcorder on and in a recording mode, close the LCD panel.

A beep will sound and the green ON/OFF (CHG) indicator will change to orange to indicate the camcorder entered standby mode.



2 When you wish to resume recording, open the LCD panel.

- The ON/OFF (CHG) indicator turns back green and the camcorder is ready to record.
- **HFS21** You can also pull out the viewfinder to start recording with the LCD panel closed. Restore the viewfinder to its original position to set the camcorder to standby mode.

IMPORTANT

- Do not disconnect the power source during standby mode (while the ON/OFF (CHG) indicator is lit in orange).

NOTES

- The camcorder will not enter standby mode if the LCD panel is closed while the ACCESS indicator is on or flashing, while a menu is being displayed, or while the viewfinder is pulled out (**HFS21** only). The camcorder may also not enter standby mode if the LCD panel is closed while the double memory card slot cover is open or when the battery charge is too low. Check that the ON/OFF (CHG) indicator changes to orange.
- **About standby mode and auto power off:**
 - The camcorder will power off automatically if left in standby mode for 10 minutes. Press **POWER** to turn on the camcorder.
 - You can select the length of time until shut-off or turn off the Quick Start function altogether with the  [Power Saving Mode]  [Quick Start (Standby)] setting.
 - The usual 5-minute auto power off setting of [Power Saving Mode] is not applicable while the camcorder is in standby mode.
- Changing the position of the mode switch while the camcorder is in standby mode will reactivate the camcorder in the operating mode selected.



Video

This chapter covers functions related to movies, including playback, advanced shooting, advanced functions and playlist and scene operations. For details about basic video shooting, refer to *Dual Shot Mode* (📖 42).

Basic Playback

Playing Back the Video

Operating modes: |

1 Press .

You can also press and hold on the wireless controller for more than 2 seconds to switch between shooting and playback mode.

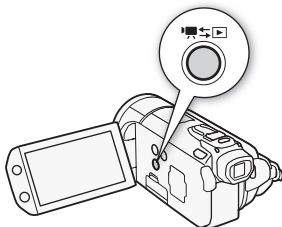

2 Open the [Original] index screen, if it is not displayed.



3 Look for the scene you want to play back.

Move the zoom lever toward **W** to show 15 scenes per page; move it toward **T** to show 6 scenes per page.



- 1 Memory being read.
- 2 Index screen currently displayed.
- 3 Drag your finger left for the next index page*.
- 4 Drag your finger right for the previous index page*.
- 5 Select a different index screen to read different content or from a different memory (📖 53).
- 6 Scene's timeline (📖 91) and recording information.
- 7 Narrow down the scenes shown in the index screen (📖 56).

* While browsing through index pages, a scroll bar will appear at the bottom of the screen for a few seconds. When you have a large number of scenes it may be more convenient to drag your finger along the scroll bar.

4 Touch the desired scene to play it back.

- Playback will start from the scene selected and continue until the end of the last scene in the index screen.
- Touch the screen during playback to display the playback controls.

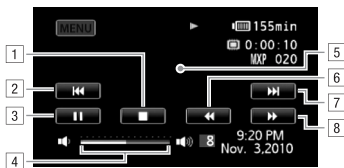

- 1 Stop the playback.
- 2 Jump to the beginning of the scene. Double-tap to jump to the previous scene.
- 3 Pause the playback.
- 4 Drag your finger left and right along the volume bar to adjust the volume.
- 5 Touch anywhere else to hide the playback controls.
- 6 Fast playback backward*.
- 7 Jump to the next scene.
- 8 Fast playback forward*.

* Touch several times to increase the playback speed to approximately 5x → 15x → 60x the normal speed. During fast playback, touch anywhere on the screen to return to normal playback.

During playback pause:



- 1 Resume playback.
- 2 Slow playback backward*.
- 3 Slow playback forward*.

* Touch several times to increase the playback speed 1/8 → 1/4 the normal speed. During slow playback, touch anywhere on the screen to return to playback pause.

! IMPORTANT

- Observe the following precautions while the ACCESS indicator is on or flashing. Failing to do so may result in permanent data loss.
 - Do not open the double memory card slot cover.
 - Do not disconnect the power source or turn off the camcorder.
 - Do not change the camcorder's operating mode.
- You may not be able to play back with this camcorder movies recorded on a memory card using another device.

i NOTES

- Depending on the recording conditions, you may notice brief stops in video or sound playback between scenes.
- During fast/slow playback, you may notice some anomalies (blocky video artifacts, banding, etc.) in the playback picture.
- The speed indicated on the screen is approximate.
- Slow reverse playback will look the same as continuous frame reverse.

The Index Selection Screen: Selecting the Content to Play Back

From the index selection screen you can select the content you want to play back (original scenes, playlist, or photos, for example). You can also select the memory from which you want to play back your recordings.

Operating modes:    |  

In any index screen, touch .

During single photo view, touch the screen once to display the controls then touch  to open the [Photos] index screen.



- 1 Touch the tab of the desired memory: built-in memory (HF S21/S20 only), memory card **A** or memory card **B**.
- 2 Touch a control button to select the content you want to play back.

Options

[Original] Original movies as you recorded them.

[Playlist] Scenes that were added to the playlist (📖 98) and may have been rearranged to your liking.

[3D Flip View] See the following section (📖 55).

[Photos] Display the photo index screen.

[SD Scenes] (HFS21/S20) Only when a memory card is selected
Scenes that were converted to standard definition to upload them to the Web (📖 146) or to create standard DVD discs (📖 140). Touch [SD Scenes] and then [For Web (MPEG-2)] or [For DVD (SD-VIDEO)] as necessary.

[Video Snapshot] To display only video snapshot scenes. Touch this control button first and then [Original] or [Playlist] as necessary.

NOTES

- Fast/slow playback modes are not available for scenes converted to standard definition. Scenes in the [SD Scenes] index screens can only be played back at normal speed.

3D Flip View

3D Flip View is a fun way to display your video recordings (original scenes) in a 3D layout, organized by recording date.

In any index screen, touch [⏮] ➤ [3D Flip View].

During single photo view, touch the screen once to display the controls then touch [📷] to open the [Photos] index screen.



- 1 Drag your finger up and down to browse through the scenes recorded in the displayed date.
- 2 Drag your finger left to go to the next date with recordings.
- 3 Touch the scene in the front to play it back.
- 4 Currently selected recording date.
- 5 Drag your finger right to go to the previous date with recordings.
- 6 Current scene / Total number of scenes recorded on the selected date.

Narrowing Down the Scenes Shown in the Index Screen

From the [Original] index screen, you can narrow down the scenes shown, leaving only scenes that were recorded on a specific date or only those scenes in which people's faces were detected.

Operating modes:    |  

Showing Only Scenes that Contain People's Faces

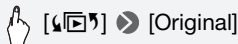

This will narrow down the scenes shown in the [Original] index screen, leaving only scenes that were recorded using face detection ( 67) and in which people's faces were detected.

- 1 Open the [Original] index screen, if it is not displayed.

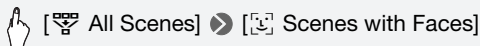

- 2 Narrow down the scenes shown.



- [ Faces] appears instead of [All Scenes]. To show all scenes again, touch [ All Scenes] and then [ Faces].

Showing Only Scenes Recorded on a Specific Date

This will narrow down the scenes shown in the [Original] or [Video Snapshot] → [Original] index screen, leaving only scenes that were recorded on the date you choose.

- 1 Open the [Original] or [Video Snapshot] → [Original] index screen.

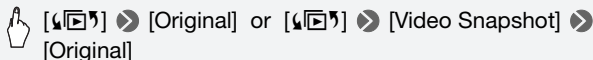

2 Open the calendar screen.

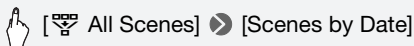

- Dates that contain scenes (that is, movies were recorded on that date) appear in black against a silver background. Dates without recordings appear grayed out.
- Touch [◀] or [▶] to jump to the previous/next calendar month that contains recordings.

3 Touch the desired date.

The selected date appears instead of [All Scenes]. To show all scenes again, touch [📅 (the date displayed on the screen)] and then [All Scenes].

NOTES

- You can change on what day to start the week for the calendar display with the [📅] [Calendar Start Day] setting.

Deleting Scenes

You can delete those scenes that you are not interested in keeping. Deleting scenes allows you also to free up space on the memory. See also *Deleting Scenes from the Playlist* (📖 99).

Operating modes:    |  

1 Open the index screen that contains the scenes you want to delete.

- [Original] or [Video Snapshot] → [Original] index screen: To delete all the scenes recorded on a specific date, narrow down the scenes shown to scenes recorded on that date (📖 56).

2 Touch [🗑️] to open the scene selection screen.

3 Touch on the individual scenes you want to delete.

- A checkmark ✓ will appear on scenes selected. Touch a selected scene again to remove the checkmark.
- To select all the scenes at once: Touch [Select All] instead of touching individual scenes. (Remove in advance any checkmarks from scenes you may have selected individually.)

4 Delete the scenes.



[Edit] ➤ [Delete] ➤ [Yes]* ➤ [OK]

* Touch [Stop] to interrupt the operation while it is in progress. Some scenes may be deleted nevertheless.

! IMPORTANT



- Be careful when deleting original recordings. Once deleted, original scenes cannot be recovered.
- Save copies of important scenes before deleting them (📖 133).
- Observe the following precautions while the ACCESS indicator is on or flashing (while scenes are being deleted).
 - Do not open the double memory card slot cover.
 - Do not disconnect the power source or turn off the camcorder.
 - Do not change the camcorder's operating mode.

i NOTES

- Deleting a scene from the [Original] index screen also deletes that scene from the playlist.
- To delete all movies and make all recordable space available again you may prefer to initialize the memory (📖 40).

Advanced Functions

Shooting Video in **M** Manual Mode

When the mode switch is set to **M** (Manual mode), you can enjoy full access to the menus and manually adjust the exposure, focus, white balance and many more of the camcorder's settings to your preference. Even in  mode, though, the camcorder can help you with the settings. For example, by using Special Scene recording programs ( 61).

Operating modes:    |  

1 Set the mode switch to **M**.

2 Turn on the camcorder.

By default, movies are recorded in the built-in memory (**HFS21/S20** only) or on memory card **A** (**HFS200**). You can select the memory that will be used to record movies ( 38).

3 Press **START/STOP** to begin recording.

Press **START/STOP** again to pause the recording.

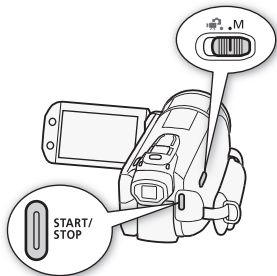

IMPORTANT

- Observe the following precautions while the ACCESS indicator is on or flashing. Failing to do so may result in permanent data loss or damage to the memory.
 - Do not open the double memory card slot cover.
 - Do not disconnect the power source or turn off the camcorder.
 - Do not change the camcorder's operating mode.
- Be sure to save your recordings regularly ( 130), especially after making important recordings. Canon shall not be liable for any loss or corruption of data.

NOTES

- The zoom, Quick Start function, power saving modes, etc. operate the same way in  mode as in  mode. For details, refer to *Dual Shot Mode* ( 42).

Selecting the Video Quality (Recording Mode)

The camcorder offers 5 recording modes. Changing the recording mode will change the recording time available on the memory. Select MXP or FXP mode for better movie quality; select LP mode for longer recording times. The following table gives approximate recording times.

Operating modes:    |  

 [FUNC.]  [MENU]    [Recording Mode] 
Desired recording mode  [X]

NOTES

- Scenes recorded in MXP mode cannot be saved onto AVCHD discs using the optional DW-100 DVD Burner. Use the supplied software **ImageMixer 3 SE** to back up such scenes.
- The camcorder uses a variable bit rate (VBR) to encode video so the actual recording times will vary depending on the content of the scenes.
- The camcorder retains the last setting used even if you set the camcorder to  mode.

Approximate recording times

◆ Default value

Recording mode →	MXP ¹	FXP ¹	XP+	SP [◆]	LP
Memory ↓					
4 GB Memory card	20 min.	30 min.	40 min.	1 hr. 10 min.	1 hr. 30 min.
8 GB Memory card	40 min.	1 hr.	1 hr. 25 min.	2 hr. 20 min.	3 hr.
16 GB Memory card	1 hr. 25 min.	2 hr. 5 min.	2 hr. 50 min.	4 hr. 45 min.	6 hr. 5 min.
32 GB Memory card/ HFS20 Built-in memory ²	2 hr. 55 min.	4 hr. 10 min.	5 hr. 45 min.	9 hr. 35 min.	12 hr. 15 min. ³
HFS21 64 GB Built-in memory ²	5 hr. 55 min.	8 hr. 20 min.	11 hr. 30 min.	19 hr. 10 min. ³	24 hr. 30 min. ³

¹ Recorded in 1,920 x 1,080 resolution. Movies recorded using other recording modes are recorded in 1,440 x 1,080 resolution.

² HFS21/S20 At the time of purchase, the built-in memory contains about 75 MB of music files.

³ A single scene can be recorded continuously for 12 hours; at that point, the camcorder will stop for about 3 seconds before resuming recording.

Special Scene Recording Programs

Recording in a very bright ski resort or capturing the full colors of a sunset or a fireworks display becomes as easy as selecting a Special Scene recording program.

Operating modes:    |  

 [FUNC.] ➤ [Rec. Programs] ➤ [Portrait] ➤
Desired recording program ➤ [X]

Options (♦ Default value)

[Portrait]♦ The camcorder uses a large aperture, to achieve a sharp focus on the subject while blurring the background.



[Sports] To record sports scenes such as tennis or golf.



[Night Scene] To record nightscapes with lower noise.

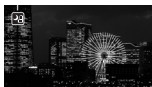

[Snow] To record in bright ski resorts without the subject being underexposed.



[Beach] To record on a sunny beach without the subject being underexposed.



[Sunset] To record sunsets in vibrant colors.



[Low Light] To record in low-light situations.













[Spotlight] To record spotlit scenes.



[ **Fireworks**] To record fireworks.



NOTES

- [ Portrait]/[ Sports]/[ Snow]/[ Beach]: The picture may not appear smooth during playback.
- [ Portrait]: The blur effect of the background increases the more you zoom in (**T**).
- [ Snow]/[ Beach]: The subject may become overexposed on cloudy days or in shaded places. Check the image on the screen.
- [ Low Light]:
 - Moving subjects may leave a trailing afterimage.
 - Picture quality may not be as good as in other modes.
 - White points may appear on the screen.
 - Autofocus may not work as well as in other modes. In such case, adjust the focus manually.
- [ Fireworks]:
 - To avoid camcorder blur (blur due to the camcorder moving) we recommend using a tripod.
 - In [ mode, slower shutter speeds are used so blur is more likely to occur. Stabilize the camcorder, for example, by mounting it on a tripod.

Cinema Mode: Giving a Cinematic Look to your Recordings

Give your recordings a cinematic look by using the [ Cine Mode] recording program. Combine this recording program with the 24 fps progressive frame rate [**PF24** PF24] or [**24F** 24F] to get the enhanced effect of the 24p Cinema Mode.



Operating modes:



To set the [Cine Mode] recording program

 [FUNC.] ➤ [Rec. Programs] ➤ [Cine Mode] ➤ [X]

Operating modes:    |  

To change the frame rate

 [FUNC.] ➤ [MENU] ➤  ➤ [Frame Rate] ➤
[PF24 PF24] or [24F 24F] ➤ [X]

NOTES

- Movies recorded with the [24F 24F] frame rate cannot be converted to standard definition using the camcorder. If you want to upload your movies to video sharing Web sites, set the frame rate to [PF24 PF24] or convert the movies to standard definition using the supplied software **ImageMixer 3 SE**.



Advanced Image Stabilization



The image stabilizer reduces camcorder blur (blur due to the camcorder moving) so you can get nice, stable shots. Select the image stabilization mode according to the shooting conditions.

Operating modes:    |  

 [FUNC.] ➤ [Image Stabilizer] ➤ Desired IS mode ➤ [X]

Options (♦ Default value in  mode)

[ Dynamic]♦ ( mode only) Compensates for a higher degree of camcorder shake, such as when shooting while walking, and is more effective as the zoom approaches full wide angle.





[ Standard], [ On] Compensates for a lower degree of camcorder shake, such as when shooting while remaining stationary, and is suitable for shooting natural-looking scenes. Use this setting when recording movies with the optional Wide-converter or Tele-converter.

[ Off] Use this setting when the camcorder is mounted on a tripod.

Powered IS



When shooting video, you can use Powered IS to make the image stabilization even more powerful. Powered IS is most effective when you are stationary and zooming in on far subjects using high zoom ratios (the more you approach the telephoto end). Holding the LCD panel with your left hand will add to the stability of the shot.

Press and hold  as long as you want to activate Powered IS.

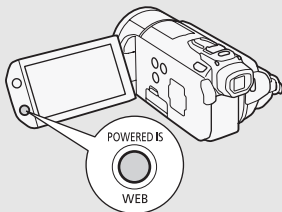
-  appears in yellow, while Powered IS is activated.
- You can change the operation of the  button (long press or toggle on/off) with the   [POWERED IS Button] setting.



NOTES





- If the degree of camcorder shake is too high, the image stabilizer may not be able to fully compensate.
- Powered IS is not available in  mode.
- For surveying and following shots, when you pan the camcorder from side to side or tilt it up and down, we recommend setting the IS mode to [ Dynamic] or [ Standard].

Pre-Recording

The camcorder will start recording 3 seconds before you press **[START/STOP]**, ensuring you do not miss important shooting opportunities. This is especially useful when it is difficult to predict when to start recording.

Operating modes:    |  

1 Activate the pre-recording function.

 **[FUNC.]**   **Pre REC**  **[ON On]**  **[X]**

-  appears.
- Repeat, selecting **[OFF Off]**, to turn off pre-recording.

2 Press **[START/STOP]**.

The scene recorded in the memory will start 3 seconds before **[START/STOP]** was pressed.

NOTES



- While pre-recording is activated, the camcorder will not emit any notification sounds.
- The camcorder will not record the full 3 seconds prior to pressing **[START/STOP]** if the button was pressed within 3 seconds of having turned on pre-recording or having finished the previous recording.
- Any of the following actions will deactivate the pre-recording function.
 - Leaving the camcorder without any operation for 5 minutes.
 - Pressing  or **[VIDEO SNAP]**.
 - Changing the position of the mode switch.
 - Changing the camcorder's operating mode.
 - Setting the camcorder to standby mode.
 - Changing any of the setup menu settings or changing the following settings in the FUNC. panel: **[Rec. Programs]**, **[White Balance]**, **[AGC Limit]**, **[Digital Effect]** or **[Image Stabilizer]**.

Face Detection





The camcorder automatically detects people's faces and uses this information to select the optimal settings for beautiful videos and photos.

Operating modes:    |  

POINTS TO CHECK

- Select a recording program other than [ Night Scene], [ Low Light] or [ Fireworks].

By default, face detection is activated. If the function was turned off, perform the following procedure to turn it on.

 [FUNC.] ➤ [MENU] ➤ [] / [] ➤ [Face Detection & Tracking] ➤ [ON On ] ➤ []

To select the main subject

If there is more than one person in the picture, the camcorder will automatically select one person it determines is the main subject. The main subject is indicated by a white face detection frame and the camcorder will optimize the settings for that person. Other faces will have gray frames.

Touch a different face on the touch screen to optimize the camcorder's settings for that person.



Main subject

NOTES

- The camcorder may mistakenly detect the faces of non-human subjects. In such case, turn face detection off.
- In certain cases, faces may not be detected correctly. Typical examples include:
 - Faces extremely small, large, dark or bright in relation to the overall picture.
 - Faces turned to the side, at a diagonal or partially hidden.

- Face detection cannot be used when the shutter speed used is slower than 1/30 (1/24 if the frame rate is set to [PF24 PF24] or [24F 24F]) or when the digital zoom is activated at more than 40x zoom (dark blue area on the zoom bar).
- When face detection is activated, the slowest shutter speed used by the camcorder is 1/30 (1/24 if the frame rate is set to [PF24 PF24] or [24F 24F]).

Touch & Track

When recording people, face detection (📖 67) will track the main subject and adjust the optimal settings. But also when recording other moving subjects such as your pet, a moving vehicle or people not facing the camera directly, you can use Touch & Track to keep your subject in focus and achieve the best results.

Operating modes:    |  

- 1 **Make sure face detection is activated (📖 67).**
- 2 **Point the camcorder at a moving subject and touch the subject on the touch screen.**
 - A white double frame will appear around the subject and track it as it moves.
 - Touch [Cancel ] to remove the frame and cancel the tracking.

NOTES

- In certain cases, Touch & Track may not be able to track the subject. Typical examples include:
 - Subjects extremely small or large in relation to the overall picture.
 - Subjects too similar to the background.
 - Subjects lacking sufficient contrast.
 - Fast moving subjects.
 - When shooting indoors with insufficient lighting.

Video Snapshot

Record a series of short scenes or capture short scenes from a movie you have previously recorded. Play your video snapshot scenes set to your favorite music (📖 93) to create your own fun music video. You will be surprised how by changing the background music, you can give your scenes an entirely new feel.



Recording Video Snapshot Scenes

Operating modes:    |  

1 Press **VIDEO SNAP**.

- A blue border appears on the screen.
- Press **VIDEO SNAP** again to return to normal video recording mode.

2 Press **START/STOP**.

- By default, the camcorder records for about 4 seconds (the blue frame serves as a visual progress bar) and then automatically returns to record pause mode. You can change the length of video snapshot scenes with the   [Video Snapshot Length] setting.
- When the camcorder stops recording, the screen will momentarily turn black as if a camera shutter had released.
- In index screens, video snapshot scenes are indicated with the  mark.

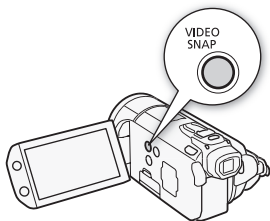



NOTES

- Changing the camcorder's operating mode will deactivate the video snapshot mode.

Digital Effects

Operating modes:    |  

 [FUNC.] ➤  Digital Effects ➤ Desired fader/effect* ➤
[X]

* You can preview the digital effect on the screen.

- The icon of the selected digital effect appears in green. Effects are applied immediately.

To fade in/out

Press **[START/STOP]** in record pause mode (●||) to start recording with a fade in. Press **[START/STOP]** while recording (●) to fade out and pause the recording.

Options (♦ Default value)

[OFF Off]♦ Select this setting when you do not intend to use the digital effects.

[E1 Black & White]* Records movies and photos in black and white.

[E2 Sepia]* Records movies and photos in sepia tones for an “old” look.

[F1 Fade Trigger/Once], **[F1 Fade Trigger/Always]**, **[F2 Wipe/Once]**, **[F2 Wipe/Always]** Select one of the faders to begin or end a scene with a fade from or to a black screen. You can choose to activate the fader only once, or every time you press **[START/STOP]** to begin or end a scene.

* Only these digital effects are available in  mode.

NOTES

- When you apply a fader, not only the picture but also the sound will fade in or out. When you apply an effect, the sound will be recorded normally.
- Faders cannot be used when recording video snapshot scenes or when pre-recording is activated.

Manually Setting the Shutter Speed or Aperture

[**P** Programmed AE] is the default automatic exposure (AE) recording program; using it, you can change functions like the white balance or image effects. Select one of the other AE recording programs to control the shutter speed or aperture.

Operating modes:





[FUNC.] ➤ [Rec. Programs] ➤ [**Tv** Shutter-Pri. AE] or [**Av** Aperture-Pri. AE] ➤ Drag your finger left and right along the dial to set the desired shutter speed (**Tv**) or aperture value (**Av**) ➤ [**X**]

Options (♦ Default value)

- [**P Programmed AE**]♦ The camcorder automatically adjusts the aperture and shutter speed to obtain the optimal exposure for the subject.
- [**Tv Shutter-Pri. AE**] Set the shutter speed value. The camcorder automatically sets the appropriate aperture value.
- [**Av Aperture-Pri. AE**] Set the aperture value. The camcorder automatically sets the appropriate shutter speed.

NOTES

- [TV Shutter-Pri. AE]:
 - On screen only the denominator is displayed – [TV 250] indicates a shutter speed of 1/250 second, etc.
 - In  mode, when the frame rate is set to [PF24 PF24] or [24F 24F], the shutter speeds available will be the following: 1/6, 1/12, 1/24, 1/48, 1/60, 1/100, 1/250, 1/500, 1/1000 and 1/2000.
 - When recording in dark surroundings, you can obtain a brighter picture by using slow shutter speeds; however, image quality may not be as good and autofocus may not work well.
 - The image may flicker when recording with fast shutter speeds.
 - **Recording movies under fluorescent lights:** If the screen starts to flicker, select [TV Shutter-Priority AE] and set the shutter speed to 1/100.
- [Av Aperture-Priority AE]: The actual range of values available for selection will vary depending on the initial zoom position.
- When setting a numeric value (aperture or shutter speed), the number displayed will flash if the aperture value or shutter speed is not appropriate for the recording conditions. In such case, select a different value.
- During exposure lock, the aperture value/shutter speed cannot be changed. Set the aperture value or shutter speed before manually adjusting the exposure.
- This function can also be assigned to the custom key/dial ( 89).

Shutter Speed and Aperture Value Guidelines



▶ With slower shutter speed you can add a nice motion blur and sense of movement.

With faster shutter speeds you can “freeze the action” for powerful images of moving subjects. ◀

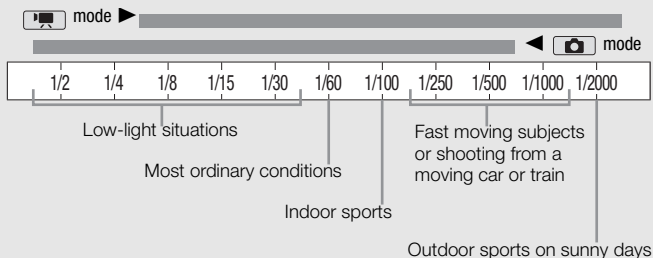

▶ With small aperture values only the subject is in focus and the background is softly blurred. Great for portraits or to isolate a single object.

With large aperture values every part of the image is clearly in focus. Good for landscapes and architectural shots. ◀

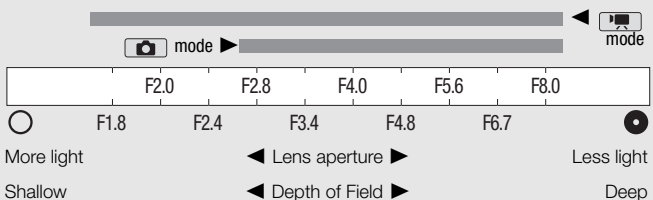

Manual Exposure Adjustment

At times, backlit subjects may appear too dark (underexposed) or subjects under very strong lights may appear too bright or glaring (overexposed). To correct this, you can adjust the exposure manually or use the Touch AE function to automatically set the optimal exposure for the subject you select. This is convenient when the brightness of the subject you want to shoot is noticeably brighter/darker than the general brightness of the image.

Operating modes:    |  

POINTS TO CHECK

- Select a recording program other than [ Fireworks].

1 Open the exposure adjustment screen.



2 Touch a subject that appears inside the frame.

- The Touch AE mark () will flash and the exposure will be adjusted automatically so the area you touched will be correctly exposed. You have the option to further adjust the exposure manually as necessary. Depending on the subject, you may want to use the [Highlights] setting as described below.
- You can touch [**M**] instead to adjust the exposure manually without activating the Touch AE function.
- The manual adjustment dial appears and the adjustment value is set at ± 0 .
- Touch [**M**] again to return the camcorder to automatic exposure.

3 Drag your finger up and down along the dial to set the exposure adjustment value.

The adjustment range may vary depending on the initial brightness of the image, and some values may be grayed out.

4 Touch [**X**] to lock the exposure at the selected value.

During exposure lock,  and the selected exposure adjustment value will appear on the screen.

To adjust the Touch AE function for highlights (Highlight AE)



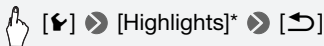

Certain subjects, like clouds or white objects, are easily overexposed and can end up appearing as bright areas where all detail is lost. Using the [Highlights] setting, you can touch the brightest area inside the  frame and the camcorder will automatically make corrections so that area is not overexposed. When you touch a dark area in the picture or the highlights are too bright, the camcorder may not be able to correctly adjust the exposure.

After step 1 above:





* Touch [Normal] to return the camcorder to normal Touch AE settings.

NOTES

- This function can also be assigned to the custom key/dial ( 89).
- If the recording program is changed during exposure lock, the camcorder will return to automatic exposure.
- When shooting subjects with a strong light source behind them, the camcorder automatically corrects for the backlight. You can turn off the automatic backlight correction with the  /   [Auto Backlight Correction] setting.

Using the Zebra Pattern

You can use the zebra pattern to identify areas that might be overexposed, so you can correct the exposure appropriately. The camcorder offers two levels of zebra pattern: With  100% only areas that will lose detail in the highlight areas will be identified, while  70% will identify also areas that are dangerously close to losing detail.



* Touch again to turn off the zebra pattern.

- The zebra pattern will appear on the overexposed areas of the picture.

NOTES

- Using the zebra pattern will not affect your recordings.

Automatic Gain Control (AGC) Limit

When recording in dark surroundings, the camcorder will automatically increase the gain to try to get a brighter picture. However, using higher gain values may result in more noticeable video noise. You can select the AGC limit to curb the amount of noise by setting the maximum gain value to be used. The smaller the AGC limit, the picture will be darker but will have less the noise.

Operating modes:    |  



[FUNC.] ➤ [AGC AGC Limit] ➤ [M Manual]* ➤

Drag your finger left and right along the dial to set the AGC limit ➤ [X]

* Touch [A Automatic] to remove the limit for the automatic gain control.

- The AGC limit selected appears on the screen.

NOTES

- This function can also be assigned to the custom key/dial ( 89).

Manual Focus Adjustment

Autofocus may not work well on the following subjects. In such case, focus manually.

- Reflective surfaces
- Subjects with low contrast or without vertical lines
- Fast moving subjects
- Through wet windows
- Night scenes

Operating modes:    |  

POINTS TO CHECK

- Adjust the zoom before you start the procedure.

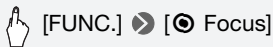

1 Open the manual focus screen.



2 Touch a subject that appears inside the frame.

- The Touch AF mark () will flash and the focusing distance will be adjusted automatically. You have the option to further adjust the focus manually as necessary.
- You can touch **[MF]** instead to adjust the focus manually without activating the Touch AF function.
- The manual focus controls and the current focusing distance appear (for reference only).
- Touch **[MF]** again to return the camcorder to autofocus.

3 Touch and hold **[▲]** or **[⏺]** to adjust the focus.

- You can use the peaking function ( 78) to help you adjust the focus manually in a more precise manner.
- The center of the screen will be magnified to help you focus more easily. You can also turn off this function with the  **[Focus Assistance]** setting.
- The focusing distance displayed will change as you adjust the focus. You can change the units used for the distance display with the  **[Distance Units]** setting.
- If you wish to focus on faraway subjects such as mountains or fireworks, touch and hold **[▲]** until the focusing distance changes to ∞ .

4 Touch **[X]** to lock the focus at the selected distance.

During manual focus, **[MF]** will appear on the screen.

NOTES

- While the optional Wide-converter or Tele-converter is attached, the focusing distance displayed will be incorrect.
- This function can also be assigned to the custom key/dial ( 89).

Using the Peaking Function

Peaking can help you achieve correct focus when focusing manually. While peaking is activated, the outlines of subjects that are properly in focus are emphasized and shown in color. You can use the black and white setting to create an even stronger contrast, making it even easier to verify if the subject is in focus.

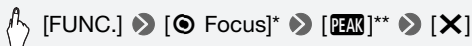

* Touch  to select the peaking settings as described below.

**Touch again to turn off the peaking function.

- The outlines of subjects correctly in focus will be shown in color.

To turn the image to black and while using peaking

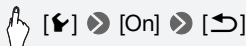

To select the color of the peaking outlines



NOTES

- Using the peaking function will not affect your recordings.

White Balance

The white balance function helps you to accurately reproduce colors under different lighting conditions so that white objects will always look truly white in your recordings.

Operating modes:



POINTS TO CHECK

- Select a recording program other than the Special Scene recording programs.



[FUNC.] ➤ [WB White Balance] ➤ Desired option* ➤ [X]

* When you select [Custom WB], set the custom white balance with the following procedure before touching [X].

To set the custom white balance







Point the camcorder at a white object, so it fills the whole screen, and touch [Set WB].

When the adjustment is completed, the [Set WB] icon stops flashing and disappears. The camcorder will retain the custom white balance even if you turn it off.

Options (♦ Default value)

- [AWB **Automatic**]♦ The camcorder automatically sets the white balance for natural looking colors.
- [☀ **Daylight**] To record outdoors on a bright day.
- [🏠 **Shade**] To record in shaded places.
- [☁ **Cloudy**] To record on a cloudy day.
- [💡 **Fluorescent**] To record under warm white, cool white or warm-white-type (3-wavelength) fluorescent lighting.
- [💡 **Fluorescent H**] To record under daylight or daylight-type (3-wavelength) fluorescent lighting.
- [💡 **Tungsten**] To record under tungsten and tungsten-type (3-wavelength) fluorescent lighting.
- [📄 **Custom WB**] Use the custom white balance setting to make white subjects appear white under colored lighting.



NOTES

- **When you select the custom white balance:**
 - Set  ➤ [Digital Zoom] to  Off].
 - Reset the white balance when you change locations or the lighting or other conditions change.
 - Depending on the light source,  may keep flashing. The result will still be better than with [AWB Automatic].
- Custom white balance may provide better results in the following cases:
 - Changing lighting conditions
 - Close-ups
 - Subjects in a single color (sky, sea or forest)
 - Under mercury lamps and certain types of fluorescent lights
- Depending on the type of fluorescent light, optimal color balance may not be obtained with  Fluorescent] or  Fluorescent H]. If the color looks unnatural, select [AWB Automatic] or  Custom WB].

Digital Tele-Converter

Using the digital tele-converter, you can digitally increase the focal length of the camcorder by a factor of approx. 1.7 and record the enlarged image at full HD resolution.

Operating modes:    |  

 [FUNC.] ➤ [ZOOM] ➤ * (digital tele-converter) ➤ 

* Touch again to deactivate the digital tele-converter.

- The center of the screen will be enlarged approximately 1.7 times.

NOTES

- You can attach the optional TL-H58 Tele-converter and use it in conjunction with this function to increase the effect.
- The digital tele-converter cannot be turned on while recording.
- While the digital tele-converter is activated, photos cannot be recorded simultaneously at [LW 3264x1840] size.

Image Effects

You can use the image effects to change the color saturation and contrast to record movies and photos with special color effects.

Operating modes:    |  

POINTS TO CHECK

- Select a recording program other than the Special Scene recording programs.

 [FUNC.] ➤ [MENU] ➤  /  ➤ [Image Effects] ➤
Desired option* ➤ [X]

* When you select [**E**c Custom Effect], set the custom image effect with the following procedure before touching [X].

To set the custom image effect

- 1 Touch [+1], [-1] or [0] to set the desired [Color Depth] level.
- 2 Touch [◀] or [▶] to select [Sharpness], [Contrast] and [Brightness] and adjust their levels the same way.



Options [♦] Default value)

- [**OFF** Off]♦ Records with no image enhancing effects.
- [**E**v Vivid] Emphasizes the contrast and color saturation.
- [**E**N Neutral] Tones down the contrast and color saturation.
- [**E**s Low Sharpening] Records subjects with softened outlines.
- [**E**d Soft Skin Detail] Softens the details in the skin tone area for a more complimentary appearance. To obtain the best effect, use this setting when recording a person in close-up. Note that areas similar to the skin color may lack in detail.
- [**E**c Custom Effect] Allows you to adjust the color depth, brightness, contrast, and sharpness of the image.
 - [Color Depth]: (-1) Shallower, (+1) Richer.
 - [Sharpness]: (-1) Softer, (+1) Sharper.
 - [Contrast]: (-1) Softer, (+1) Sharper.
 - [Brightness]: (-1) Darker, (+1) Brighter.

Mini Video Light

You can turn on the mini video light to shoot video or take photos in dark places.

Operating modes:    |  

 [FUNC.] ➤ [ Video Light] ➤ [**ON** On] ➤ []

- The mini video light pops up and lights up and  appears on the screen.
- Repeat, selecting [**OFF** Off], to turn off the mini video light and gently press the pop-up mini video light to close it.

NOTES

- We recommend not using the mini video light while the optional Wide-converter or Tele-converter is attached; its shadow can appear on the screen.

Using an External Video Light

You can use the optional VL-5 Video Light or VFL-2 Video Flash Light when you need a video light that is stronger than the built-in mini video light.

Attach the optional video light to the mini advanced shoe.

- Refer to *Using the Mini Advanced Shoe* (📖 86).
-  appears when you turn on the optional video light (ON or AUTO). For details about using the optional video light, refer to the instruction manual of the accessory used.

NOTES

- When an optional video light is attached to the mini advanced shoe, the built-in mini video light will be disabled. To use the built-in mini video light, turn off the optional video light.

Self Timer

Operating modes:

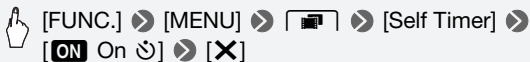

- appears.
- Repeat, selecting [**OFF** Off], to turn off the self timer.

mode: In record pause mode, press **[START/STOP]**.

The camcorder starts recording after a 10-second countdown*. The countdown appears on the screen.

mode: Press **[PHOTO]**, first halfway to activate the autofocus and then fully.

The camcorder will record the photo after a 10-second countdown*. The countdown appears on the screen.

* 2 seconds when using the wireless controller.

NOTES

- Once the countdown has begun, any of the following actions will cancel the self timer.
 - Pressing **[START/STOP]** (when recording movies) or **[PHOTO]** fully (when recording photos).
 - Turning off the camcorder.
 - Changing the camcorder's operating mode.
 - Setting the camcorder to standby mode.

Audio Recording Level

You can adjust the audio recording level of the built-in or an external microphone. You can display the audio level indicator while recording.

Operating modes:



Manual Adjustment of the Audio Recording Level

1 Open the manual audio recording level adjustment screen.

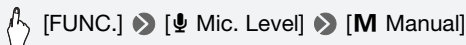

- The audio level indicator and current audio recording level will appear on the screen.
- Touch [**A** Automatic] to return the camcorder to automatic audio recording levels.

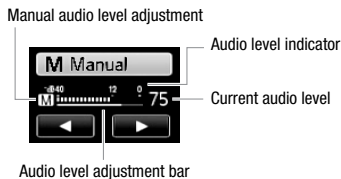

2 Touch and hold [◀] or [▶] to adjust the audio recording level as necessary.

As a guideline, adjust the audio recording level so that the audio level meter will go to the right of the -12 dB mark (yellow area) only occasionally.



3 Touch [X] to lock the audio recording level at the current level.

To display the audio level indicator

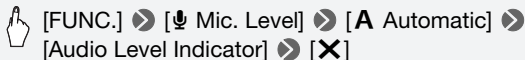

Usually, the audio level indicator will be displayed only after activating the manual adjustment of the audio recording level. You can choose to display it also when the audio level is adjusted automatically.



NOTES

- When the audio level meter reaches the red point (0 dB), the sound may be distorted.
- If the audio level is too high and the sound gets distorted, activate the microphone attenuator with the   [Microphone Attenuator] setting (or [Surround Mic Attenuator] when the optional SM-V1 Surround Microphone is attached to the camcorder).
- We recommend using headphones to check the sound level while adjusting the audio recording level or when the microphone attenuator is activated.
- This function can also be assigned to the custom key/dial ( 89).

Using Headphones

Use headphones for playback or to check the audio level while recording. The headphones are connected to the AV OUT/ terminal, which is used for both the headphones and the audio/video output. Before connecting the headphones, follow the procedure below to change the function of the terminal from AV output to  (headphones) output.





Operating modes: *   |  

* Headphones can be used also in  mode but the function of the terminal cannot be changed in this mode. Change the setting in advance in one of the other operating modes.

 [FUNC.]*  [MENU]    [AV/Headphones] 
[Headphones] 

To close the menu:  [X]

To continue adjusting the volume:



 [>]  [Volume]  Drag your finger left and right along the volume bar to adjust the volume  [X]

* Only when performing the procedure in  mode.

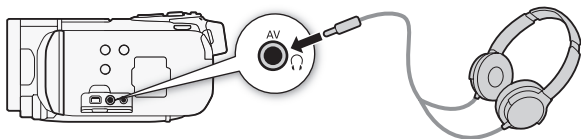

-  appears.





To adjust the volume during playback

In  mode, and in  mode during slideshow playback, adjust the headphones volume the same way you adjust the speaker's volume ( 51).

IMPORTANT

- When using headphones, make sure to lower the volume to an appropriate level.
- Do not connect the headphones to the AV OUT/ terminal if the  icon does not appear on the screen. The noise output in such case may be harmful to your hearing.

NOTES

- Use commercially available headphones with a \varnothing 3.5 mm minijack.
- Even if [AV/Headphones] was set to [ Headphones] in a playback mode, the function of the AV OUT/ terminal will return automatically to AV output when you turn off the camcorder.

Using the Mini Advanced Shoe

Using the mini advanced shoe, you can attach to the camcorder a range of optional accessories to expand its functionality. For details about optional accessories available for use with your camcorder, refer to *Accessories* ( 201). For details about how to attach and use the accessories, refer also to the instruction manual of the accessory used.

- 1 Retract the mini advanced shoe cover in the direction of the arrow.
- 2 Attach the optional accessory to the mini advanced shoe.

When a compatible accessory is attached to the mini advanced shoe, “S” will appear on the screen.



Example: Attaching an optional DM-100 Directional Stereo Microphone.

i NOTES

- Accessories designed for the Advanced Accessory Shoe cannot be used with this camcorder. Look for video accessories bearing this logo to ensure compatibility with the **mini advanced shoe**.



Using an External Microphone

When recording in very quiet surroundings, the built-in microphone may pick up the sound of the camcorder's internal machinery. In such case, we recommend using an external microphone.

Using the SM-V1 Surround Microphone or DM-100 Directional Stereo Microphone

Using the SM-V1 you can add a sense of depth and presence to your recordings with 5.1ch surround sound. Using the DM-100 you can accurately record audio coming directly from the direction you are recording.

Operating modes:    |  

Attach the optional SM-V1 Surround Microphone or DM-100 Directional Stereo Microphone to the mini advanced shoe.

Refer to *Using the Mini Advanced Shoe* (86).

“S” appears. For details about using the optional external microphone, refer to the instruction manual of the accessory used.



Using other microphones

You can also use commercially available microphones. Connect the external microphone to the MIC terminal. Use commercially available condenser microphones with their own power supply. You can connect almost any stereo microphone with a \varnothing 3.5 mm plug but audio recording levels may vary.

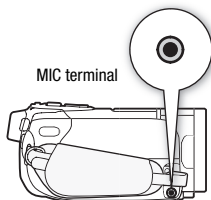

i NOTES

- **Playing back recordings made with the optional SM-V1 Surround Microphone:** You can enjoy 5.1ch surround sound playback on HDTVs compatible with 5.1ch surround sound connected to the camcorder using an HDMI cable. Audio output from the AV OUT/⌂ terminal (including headphone output) will be converted to 2ch stereo. The camcorder's built-in speaker is monaural.
- When an external microphone is connected to the camcorder, [Wind Screen] will automatically be set to [OFF Off].
- When using the optional SM-V1 Surround Microphone, change the microphone's directionality mode with the [Surround Mic Directionality] setting.
- If the audio level is too high and the sound gets distorted, adjust the audio recording level manually (83) or activate the microphone attenuator with the [Microphone Attenuator] setting (or [Surround Mic Attenuator] when the optional SM-V1 Surround Microphone is attached to the camcorder).



Using the Custom Key and Dial

You can assign to the **CUSTOM** button and dial one of five frequently used functions. You can then adjust the selected function using the **CUSTOM** button and dial, without having to access any menus.

To select the function of the custom key using the menu

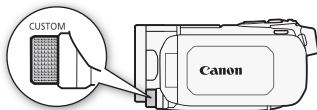
Operating modes:    |  



 [FUNC.] ➤ [MENU] ➤  /  ➤
[Custom Key/Dial] ➤ Desired function ➤ [X]















To select the function of the custom key using the custom key

- 1 Press and hold **CUSTOM** for about 2 seconds.

The icons of the functions that can be assigned to the custom key appear in a row.

- 2 Turn the custom dial to select the desired function and press **CUSTOM**.

Options Default value)

- [OFF Off]** Use this setting if you do not intend to use the custom key and dial.
- [Focus]** Manual focus ( 76). Press  to turn the manual focus on/off and turn the dial to adjust the focus.
- [Exposure]** Manual exposure adjustment ( 74). Press  to turn the manual exposure on/off and turn the dial to compensate the exposure.
- [Tv / Av]** Press  when the recording program is set to [Tv Shutter-Pri. AE] to display the shutter speed dial, and turn the dial to select the shutter speed. Press  when the recording program is set to [Av Aperture-Pri. AE] to display the aperture dial, and turn the dial to select the aperture value ( 71).
- [Mic. Level]*** Adjust the audio recording level ( 83). Press  to turn the manual adjustment of the recording level on/off and turn the dial to adjust the audio recording level.
- [AGC AGC Limit]*** Press  to turn the AGC limit on/off and turn the dial to select the maximum value for the automatic gain control ( 76).

* Available only in  mode.

Using a Zoom Remote Controller

You can attach the optional ZR-2000 or ZR-1000 Zoom Remote Controller to the camcorder to use certain functions while viewing the picture on an external monitor without touching the camcorder. This is particularly useful while the camcorder is mounted on a tripod and you want to ensure maximum stability of a shot.

Operating modes:



Connect the optional ZR-2000 or ZR-1000 Zoom Remote Controller to the **REMOTE** terminal on the camcorder.

For details about using the zoom remote controller, refer to the instruction manual of the ZR-2000 or ZR-1000.

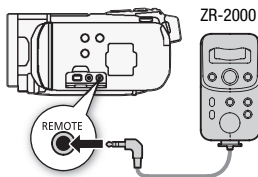

Functions Available with the Zoom Remote Controller

Using the ZR-2000 or ZR-1000: turning the power on/off, starting/stopping a recording, zoom, focus adjustment and displaying on-screen displays on an external monitor.

Using the ZR-2000 only: switching between autofocus and manual focus, Push AF*, focus assistance (MAGNIFYING button), and peaking (PEAKING button).

* The Push AF function allows you to switch to autofocus temporarily during manual focus.

NOTES

- In  mode, the only available functions are turning the power on/off, starting/stopping a recording, and zoom.

Selecting the Playback Starting Point

If you have a very long scene, you may want to start playing back the scene from a certain point. You can use the movie timeline to break the scene to segments at fixed time intervals ranging from 6 seconds to 6 minutes. If you recorded movies using face detection ( 67), you can display the scene divided into segments every time the camcorder registered a change in the main subject of the scene.

Operating modes:    |  

- 1 Open the [Original] or [Playlist] index screen.

2 Open the scene's [Timeline] screen.

 [i] ➤ the desired scene

The [Timeline] screen appears. The large thumbnail will show the first frame of the scene. Below it, the timeline ruler shows frames taken from the scene at fixed intervals.

3 Touch the desired frame in the timeline ruler to start playing back the scene from that point.



- 1 Touch twice to return to the index screen.
- 2 Previous/next scene.
- 3 Drag your finger left along the ruler to display the next 5 frames.
- 4 Current scene / Total number of scenes.
- 5 Scene's recording mode and length.
- 6 Recording date and time.
- 7 Drag your finger right along the ruler to display the previous 5 frames.
- 8 Currently selected interval between frames (or [Faces]).

To change the interval between frames

 [6 sec] ➤ Desired interval ➤ [↔]

To display changes in the scene's main subject

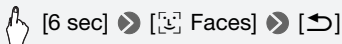

- The timeline ruler will show frames taken from the scene every time the main subject detected by the camcorder changed.

NOTES

- For a single scene, up to 100 changes in main subject will appear in the [Timeline] screen when [Faces] is selected.

Playing Back Scenes Set to Background Music

You can play back video snapshot scenes, scenes in the playlist and photo slideshows set to background music (instead of the original sound). You can use one of the supplied music tracks or connect an external audio player to use your favorite songs as background music.

Operating modes:    |  

Using One of the Supplied Music Tracks as Background Music

The supplied Camcorder Supplemental Disc contains 3 music tracks you can use as background music. **HFS21/S20**: The music files comes pre-installed in the built-in memory.

POINTS TO CHECK

- To play back scenes or a slideshow of photos recorded on one of the memory cards, you will need to transfer the music tracks to the corresponding memory card in advance. For details, refer to the 'ImageMixer 3 SE Software Guide' (PDF file).
- 1 Open the [Playlist], [Video Snapshot] → [Original]/[Playlist] or [Photos] index screen.

2 Open the music track selection screen.



 [MENU] ➤  /  ➤ [Select Music] ➤ [ON On] ➤ [▲] or [▼] to select the desired music track* ➤ [X]

* Touch [OFF Off] to play back the scenes with the sound recorded originally or to play back the photo slideshow without any music.



- 1 Select the desired music track.
- 2 Play back the original sound (no background music).
- 3 Delete the music track selected.
- 4 Listen to the music track selected. Touch again (■) to stop the playback.

3 Back in the index screen, touch a scene to start the playback set to the selected music track.

In  mode, touch a photo to go to single photo view and continue with the slideshow procedure ( 116).

To delete a music track

In the music track selection screen, touch [▲] or [▼] to select the track you want to delete.

 [X] ➤ [Yes]

Using an External Audio Player for Background Music

Use your favorite songs as background music by connecting an external player.

POINTS TO CHECK

- You will need a commercially available audio cable with at least one mini-stereo plug (to connect to the MIC terminal on the camcorder); the other end will depend on external player used).
- 1 Open the [Playlist], [Video Snapshot] → [Original]/[Playlist] or [Photos] index screen.
 - 2 Activate the external audio input.





- 3 Connect the external player to the camcorder's MIC terminal.
- 4 Adjust the audio input as necessary.
 - Start the music playback on the external player and adjust its volume according to the onscreen indications. When the audio input is in the correct range, stop the music playback and touch [X] on the camcorder.
 - Touch [External Player Link] to link the video playback to the start/end of the music from the external player.

Playback with the video/slideshow linked to the external audio

- 5 Start the music playback on the external player.
 - Playback will start from the first scene or photo in the index screen.
 - When the external audio input stops, the video playback will pause. When the external audio input is restored, video playback will resume automatically.
 - When you play back the slideshow linked to the external audio, the photos will be displayed continuously until the music stops. When the external audio input stops, the slideshow will stop as well.

Playback with the video not linked to the external audio

5 Back in the index screen, touch a scene to start the video playback.

In  mode, touch a photo to go to single photo view and continue with the slideshow procedure ( 116).

6 Start the music playback on the external player.

IMPORTANT

- If you use copyrighted songs and music tracks in your video creations, remember that music under copyright may not be used without permission from the copyright holder, except for cases permitted under applicable laws, such as for personal use. Make sure to follow applicable laws when using music files.

NOTES

- You can also add to the playlist just the video snapshot scenes you want to watch and arrange their playback order.
- Initializing a memory card will permanently erase any music files you may have transferred to the card. (**HFS21/S20** The music files that come pre-installed in the built-in memory will be restored after it is initialized.)
 - Windows users: Use the supplied software **ImageMixer 3 SE** to transfer music files from the supplied Camcorder Supplemental Disc to a memory card after it is initialized. For details, refer to the 'ImageMixer 3 SE Software Guide' (PDF file).
 - Mac OS users: Use Finder to transfer music files from the [MUSIC] folder on the supplied Camcorder Supplemental Disc to a memory card after it is initialized. Refer to *About the music files* ( 212) for the folder structure of the memory card.
- Transfer music files to the memory card that contains the recordings you want to play back with background music.
- **About video playback linked to the external player:**
 - In some cases, the video playback may not be correctly linked to the external player. For example, if the volume of external player is too low or if the audio signal contains a lot of noise, etc.
 - When you connect the MIC terminal to the audio outputs on the external player and cannot adjust the strength of the signal, the camcorder will automatically decrease the volume of the external player when the audio signal is too loud.

Onscreen Displays and Data Code

You can turn most onscreen displays on or off.

Operating modes:    |  

Repeatedly press **[DISP.]** to turn the onscreen displays on/off in the following sequence:

,  mode:

- All displays on
- Most displays off*

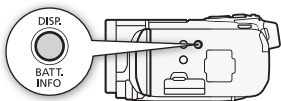

 mode**:

- All displays on
- Only data code on
- All displays off

 mode**:





- All displays on
- Only recording date and time on
- All displays off

* Pressing **[DISP.]** will turn off most of the icons and displays that appear automatically but will not remove onscreen displays that were turned on manually (for example, onscreen markers or the audio level meter).

**Touch the screen to display the playback controls.

About the Data Code

With every scene or photo recorded, the camcorder keeps a data code (date/time of recording, information about the camera setup, etc.). In

 mode, this information is displayed within the Exif information panel while the playback controls are displayed on the screen; in  mode, you can select the information to be displayed with the   [Data Code] setting.

Playlist and Scene Operations

Editing the Playlist: Adding, Deleting, Moving and Playing Back

Create a playlist to play back only the scenes you prefer and in the order of your choice. You can play back the scenes in the playlist using your favorite song as background music (📖 93).

Operating modes:    |  

Adding Scenes to the Playlist

1 Open the [Original] or [Video Snapshot] → [Original] index screen.

To add to the playlist all the scenes recorded on a specific date, narrow down the scenes shown to scenes recorded on that date (📖 56).

2 Touch [☑] to open the scene selection screen.

3 Touch on the individual scenes you want to add to the playlist.

- A checkmark ✓ will appear on scenes selected. Touch a selected scene again to remove the checkmark.
- To select all the scenes at once: Touch [Select All] instead of touching individual scenes. (Remove in advance any checkmarks from scenes you may have selected individually.)

4 Add the scenes to the playlist.

 [Edit] ➤ [Add to Playlist] ➤ [Yes] ➤ [OK]

- Scenes are added to the playlist on the same memory they are recorded on.

NOTES

- Deleting or moving scenes in the playlist will not affect the original recordings.
- Scenes that were edited using the supplied software **ImageMixer 3 SE** and were then written back to the camcorder cannot be added to the playlist.

- You can copy scenes from the built-in memory (**HFS21/S20** only) or from memory card **A** to memory card **B** (📖 130) to include in that memory card's playlist also scenes that were originally recorded in other memories.

Deleting Scenes from the Playlist

Deleting scenes from the playlist will not affect your original recordings.

1 Open the [Playlist] index screen.

You can touch [📷] ➤ [Video Snapshot] ➤ [Playlist] to open the playlist of video snapshot scenes.

2 To delete a single scene, touch [i] and touch the scene you want to delete.

- The [Timeline] screen appears.
- This step is not necessary to delete the entire playlist.

3 Delete the scenes from the playlist.

 [Edit] ➤ [Delete] ➤ [Yes]* ➤ [OK]

* If you selected to delete all the scenes in the playlist, touch [Stop] to interrupt the operation while it is in progress. Some scenes will be deleted nevertheless.

Moving Scenes in the Playlist

Move the scenes in the playlist to play them back in the order of your choice.

1 Open the [Playlist] index screen.

You can touch [📷] ➤ [Video Snapshot] ➤ [Playlist] to open the playlist of video snapshot scenes.

2 Touch [i] and touch the scene you want to move.

The [Timeline] screen appears.

3 Move the scene.

 [Edit] ➤ [Move] ➤ Touch an empty box on the screen to select the desired position ➤ [OK] ➤ [Yes]

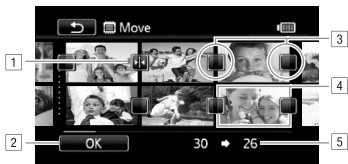

- 1 Destination icon.
- 2 Move the scene to the position indicated by the destination icon.
- 3 Touch an empty box to select it as the destination.
- 4 Scene selected to be moved.
- 5 Original position of the scene and currently selected destination.



Capturing Photos and Video Snapshot Scenes from a Movie

You can capture video snapshot scenes, single photos or a series of continuous photos from a previously recorded scene. For example, you may want to print photos from video recorded at a party or create a small video clip using video snapshot scenes from the highlights of an event.

Operating modes:    |  

Capturing a Video Snapshot Scene

- 1 Open the index screen that contains the scene from which you want to capture the video snapshot scene.
- 2 Play back the desired scene.
- 3 Press **[START/STOP]** to capture the video snapshot scene.

The camcorder captures the video snapshot scene for about 4 seconds (the blue frame serves as a visual progress bar), and then enters playback pause mode. You can change the length of video snapshot scene you capture with the   [Video Snapshot Length] setting.

- 4 Touch **[■]** to return to the index screen.

NOTES

- A video snapshot scene can be captured only during playback; it cannot be captured during playback pause mode.
- The captured video snapshot scene is saved to the same memory that contains the source scene.
- Video snapshot scenes cannot be captured from any of the following types of scenes.
 - Scenes shorter than 1 second
 - Scenes that were edited using the supplied software **ImageMixer 3 SE** and were then written back to the camcorder.
- When the source scene is itself a video snapshot scene, you may not be able to capture a video snapshot scene depending on the length of the source scene and the length currently selected for video snapshot scenes.
- When you start capturing a video snapshot scene less than 1 second from the end of the scene, the video snapshot scene will be captured starting from the beginning of the following scene.
- During the playback of video snapshot scenes captured from a previously recorded movie, you may notice some anomalies in the picture/sound at the point where the playback switches to a new scene.

Capturing Photos

You can capture a single photo or a series of photos. The size of the captured photos will be [MW 1920x1080] and it cannot be changed, but you can select the photo quality.

Please read the IMPORTANT section ( 102) before using an Eye-Fi card.

Operating modes:    |  

To select the photo capture settings



[MENU] >  > [Photo Capture from Video] > [□ Single Photo] or [ Photo Sequence] > [

Continue from the same menu:

[Photo Capture Quality] > Desired photo quality* > [X]

* The number displayed indicates the approximate number of photos that can be recorded with the current quality setting.

To capture the photos

- 1 Play back the scene from which you want to capture the photo.
- 2 Pause the playback at the point you want to capture.
- 3 Press **[PHOTO]** fully.

To capture a photo sequence, hold **[PHOTO]** pressed down. The scene will be played back by frames and each frame captured as a separate photo.

- 4 Touch **[■]** to return to the index screen.

! IMPORTANT

- When capturing photos on an Eye-Fi card in memory card slot **B**, photos will be uploaded automatically if you are within the range of a configured network. Always verify that Eye-Fi cards have been approved in the country/region of use. See also *Using an Eye-Fi card* ( 150).

i NOTES

- The data code of the photos will reflect the date and time of recording of the original scene.
- Photos captured from a scene with a lot of fast movement may be blurred.
- Photos will be recorded on the memory selected for recording photos.
-  Photo Sequence:
 - Up to 100 photos can be captured at a time.
 - The photo sequence capture will stop when the end of the scene is reached (playback will pause at the beginning of the following scene).
 - Photos will be captured at intervals of 1/30 second (1/24 second, if the scene was recorded at a frame rate of **[PF24 PF24]** or **[24F 24F]**).

Dividing Scenes

You can divide scenes (original scenes only) in order to leave out the best parts and later cut out the rest.

Operating modes:    |  

- 1 Open the **[Original]** index screen.

- 2 Select the scene you want to divide and touch it to start playing it back.
- 3 Pause the playback at the point where you want to divide the scene.
- 4 Open the scene division screen.

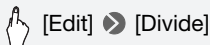

5 Bring the scene to a precise point, if necessary.

- During playback pause: Touch [▶] to play back the scene. Touch [◀|||] or [|||▶] to jump a frame backward/forward.
- During playback: Touch [|||] to pause the playback. Touch [◀◀] or [▶▶] for fast playback backward/forward.

6 Divide the scene.

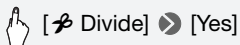

- The video from the division point to the end of the scene will appear as a new scene in the index screen.

NOTES

- When advancing/reversing frames while dividing the scenes, the interval between frames is about 0.5 seconds.
- If the scene cannot be divided at the point where you paused the playback, advance/reverse a frame and then divide the scene.
- During the playback of a scene that was divided, you may notice some anomalies in the picture/sound at the point where the scene was cut.
- The following scenes cannot be divided:
 - Video snapshot scenes and other scenes that are too short (less than 3 seconds).
 - Scenes that were edited using the supplied software **ImageMixer 3 SE** and were then written back to the memory.
- Scenes cannot be divided within 1 second from the beginning or the end of the scene.



Photos

Refer to this chapter for details on taking photos (advanced shooting functions), viewing photos and printing them. For details about basic photo shooting, refer to *Dual Shot Mode* (📖 42).

Basic Playback

Viewing Photos

Operating modes:    |  

1 Press .

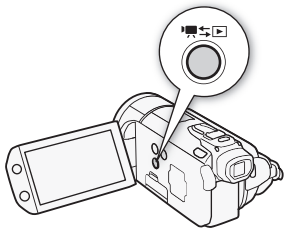

2 Open the [Photos] index screen, if it is not displayed.



3 Look for the photo you want to play back.

Move the zoom lever toward **W** to show 15 photos per page; move it toward **T** to show 6 photos per page.



- 1 Memory being read.
- 2 Index screen currently displayed.
- 3 Drag your finger left for the next index page.
- 4 Drag your finger right for the previous index page.
- 5 Select a different index screen to read different content or from a different memory (📖 53).

4 Touch the photo you wish to view.

- The photo is displayed in single photo view.
- Drag your finger left/right to browse through the photos one by one.

To return to the index screen from single photo view

- 1 Touch the screen to display the playback controls.
- 2 Touch [📺].

Photo Jump Function

When you have recorded a large number of photos, you can jump easily through the photos using the scroll bar.

- 1 Touch the screen to display the playback controls.
- 2 Jump through the photos using the scroll bar.



[📺] ➡ Drag your finger left and right along the scroll bar ➡ [↶]

IMPORTANT

- Observe the following precautions while the ACCESS indicator is on or flashing. Failing to do so may result in permanent data loss.
 - Do not open the double memory card slot cover.
 - Do not disconnect the power source or turn off the camcorder.
 - Do not change the camcorder's operating mode.
- The following image files may not be displayed correctly.
 - Images not recorded with this camcorder.
 - Images edited on or uploaded from a computer.
 - Images whose file names have been changed.

Deleting Photos

You can delete those photos that you are not interested in keeping.

Operating modes:    |  

Deleting a Single Photo

- 1 In single photo view, select the photo you want to delete.
- 2 Touch the screen to display the playback controls.
- 3 Delete the photo.

 [Edit] > [Delete] >  Proceed > [Yes]

- 4 Drag your finger left/right to select another photo to delete or touch .

Deleting Photos from the Index Screen

- 1 Open the [Photos] index screen.

  > [Photos]

- 2 Touch  to open the photo selection screen.

3 Touch on the individual photos you want to delete.

- A checkmark ✓ will appear on photos selected. Touch a selected photo again to remove the checkmark.
- To select all the photos at once: Touch [Select All] instead of touching individual photos. (Remove in advance any checkmarks from photos you may have selected individually.)

4 Delete the photos.



* Touch [Stop] to interrupt the operation while it is in progress. Some photos will be deleted nevertheless.

IMPORTANT

- Be careful when deleting photos. Deleted photos cannot be recovered.
- Protected photos cannot be deleted.

Additional Functions

Taking Photos in **M** Manual Mode



Operating modes:    |  

1 Set the mode switch to **M**.

2 Turn on the camcorder.

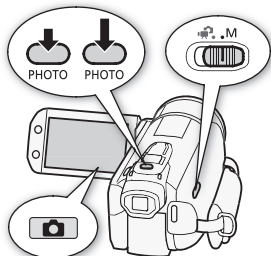
- By default, photos are recorded in the built-in memory (**HFS21/S20** only) or on memory card **A** (**HFS200**). You can select the memory that will be used to record photos (📖 38).
- Please read the **IMPORTANT** section before using an Eye-Fi card.



3 Touch  to switch to  mode.

4 Press  halfway.

Once the focus is automatically adjusted,  will turn green and one or more AF frames will appear.



5 Press  fully.

The ACCESS indicator will flash as the photo is being recorded.



IMPORTANT

- Observe the following precautions while the ACCESS indicator is on or flashing. Failing to do so may result in permanent data loss.
 - Do not open the double memory card slot cover.
 - Do not disconnect the power source or turn off the camcorder.
 - Do not change the camcorder's operating mode.
- When recording photos on an Eye-Fi card in memory card slot **B**, photos will be uploaded automatically if you are within the range of a configured network. Always verify that Eye-Fi cards have been approved in the country/region of use. See also *Using an Eye-Fi card* (📖 150).

NOTES

- If the subject is not suitable for autofocus,  turns yellow. Adjust the focus manually ( 76).
- When the subject is too bright, [Overexp.] will flash on the screen. In such case, use the optional 58 mm ND4-L or ND8-L filter.

Deleting a Photo Right After Recording It

You can delete a photo you have just recorded while reviewing it within the time set for the   [Photo Review Time] option.

Operating modes:    |  

While reviewing the photo immediately after recording:

   [Yes]







NOTES

- If you press  during the photo review time, the photo will continue to be displayed indefinitely. Press  halfway to return to normal shooting mode.

Selecting Photo Size and Quality

Photos are recorded as JPG files. As a general rule, select a larger photo size for higher quality. Select the [LW 3264x1840] size for photos with an aspect ratio of 16:9.

Operating modes:    |  

 [FUNC.]  [MENU]    [Photo Quality/Size] 
Desired photo quality* (top row) 
Desired photo size* (bottom row)  [X]



* The number displayed on the right corner indicates the approximate number of photos that can be recorded with the current quality/size setting.



Options

Large capacity memory cards, like those usually used for video recording, can contain a very large number of photos. As a reference, the number of photos that can be recorded on a 1 GB memory card is given in the following table.

Approximate number of photos available on a 1 GB memory card

◆ Default value

Memory card	Photo quality		
	 [Super Fine]	 ◆ [Fine]	 [Normal]
L 3264x2456◆	170	260	520
LW 3264x1840	230	345	695
M 1920x1440	505	760	1,500
MW 1920x1080 ¹	670	1,000	1,970
S 640x480	4,395	6,350	11,430 ²

¹ This size is only available for simultaneous recording in  mode or  mode or for capturing photos from a movie ( 100).

² Approximate number of photos that can actually be recorded on the memory card. (The maximum number of remaining photos displayed on the screen is 9999.)

NOTES

- The actual number of photos that can be recorded will vary depending on the subject and shooting conditions.
- The camcorder retains the last setting used even if you set the camcorder to  mode.
- When printing photos, use the following guidelines as a reference for selecting the print size.
 - **L** 3264x2456: To print photos up to A3 size (29.7 x 42 cm, 11.7 x 16.5 in.).
 - **M** 1920x1440: To print photos up to L size (9 x 13 cm, 3.5 x 5 in.) or postcard size (10 x 14.8 cm, 4 x 6 in.).
 - **S** 640x480: To send photos as e-mail attachments or to post on the Web.
 - **LW** 3264x1840, **MW** 1920x1080: To print photos with a 16:9 aspect ratio. (Wide-sized photo paper is required.)

Flash



You can use the flash to take photos in dark places.

Operating modes:    |  

POINTS TO CHECK

- Select a recording program other than [ Fireworks].





1 Select the flash mode.

 [FUNC.] ➤ [ Flash] ➤ Desired option ➤ [

- The icon of the selected flash mode appears.
- #### 2 Press **[PHOTO]**, first halfway to activate the autofocus and then fully to record the photo.

Depending on the setting selected and shooting conditions, the flash will pop up and fire. After using the flash, gently press the pop-up flash to close it.

Options ^(♦ Default value)



- [ Automatic]♦** The flash fires automatically according to the brightness of the subject.
- [ Red-Eye Auto]** The flash fires automatically according to the brightness of the subject. The assist lamp lights up to reduce the red-eye effect.
- [ Flash On]** The flash always fires.
- [ Flash Off]** The flash does not fire.

Using the VFL-2 Video Flash Light









You can use the optional VFL-2 Video Flash Light as an external flash when its POWER switch is set to  ON. The procedure for setting the external flash is the same as for the built-in flash.

Attach the optional VFL-2 Video Flash Light to the mini advanced shoe.

Refer to *Using the Mini Advanced Shoe* ( 86).

 appears when you turn on the video flash light ( ON). For details about using the video flash light, refer to the instruction manual of the VFL-2.

NOTES

- The flash will not fire in the following cases:
 - When the flash mode is set to [ Automatic] or [ Red-Eye Auto] and you manually adjust the exposure.
 - During auto exposure bracketing.
 - When the flash mode is set to [ Automatic] or [ Red-Eye Auto] and the recording program is set to [ Night Scene].
 - When using an optional video light.
- **About the AF-Assist Lamp:** While you press  halfway, if the surroundings of the subject are too dark, the mini video light may pop up and the assist lamp may light up briefly in order to enable the camcorder to focus more accurately (AF-assist lamp).
 - You can also set [  [AF-Assist Lamp] to [ Off] so the assist lamp is not activated.
 - The camcorder may not be able to focus even if the AF-assist lamp is on.
- The practical range of the flash is approx. 1 to 2 m (3.3 to 6.6 ft.). The practical range with the VFL-2 attached is approx. 1 to 4 m (3.3 to 13.1 ft.). In any case, the actual range will depend on the recording conditions.
- The range of the flash decreases in continuous shooting mode.
- For red-eye reduction to be effective, the subject needs to look at the assist lamp. The degree of reduction depends on the distance and on each individual.
- The flash mode cannot be selected when the exposure is locked.
- We recommend not using the flash while the optional Wide-converter or Tele-converter is attached; its shadow can appear on the screen.



Drive Mode: Continuous Shooting and Exposure Bracketing

Take a series of photos of a moving subject or record the same picture in 3 levels of exposure in order to choose later the photo you like the best.

Operating modes:    |  

POINTS TO CHECK

- Select a recording program other than [ Fireworks].

 [FUNC.] ➤ [Drive Mode] ➤ Desired option ➤ []

Options (♦ Default value)

Single♦ Records a single photo.

AE Bracketing The camcorder records 3 photos using 3 different exposures (dark, normal, light in 1/2 EV steps), allowing you to choose the photo you like the best.

Continuous, [] **Hi-Speed Cont.**

Captures a series of up to 60 photos as long as you hold **[PHOTO]** pressed down. There are two continuous shooting speed settings: normal (approx. 3 photos/second) and high speed (approx. 5 photos/second).

Continuous Shooting/Hi-Speed Continuous Shooting

- 1 Press **[PHOTO]** halfway to activate the autofocus.
- 2 Press **[PHOTO]** fully and hold it pressed down.

Auto Exposure Bracketing

Press **[PHOTO]**, first halfway to activate the autofocus and then fully to record the 3 photos.

NOTES

- Continuous shooting speeds are approximate and vary depending on recording conditions and subjects.









- When the flash is used, continuous shooting speed will decrease to approx. 2.1 photos/second. Continuous shooting speed will decrease also when using slow shutter speeds (1/30 or slower).

Taking Photos while Recording Movies (Simultaneous Recording)

You can record photos even while the camcorder is set to  mode. Moreover, you can capture the photo at the same time you are recording video. Photos recorded with simultaneous recording will have the same aspect ratio of movies (16:9).

Please read the IMPORTANT section ( 114) before using an Eye-Fi card.

Operating modes:    |  



 [FUNC.]  [MENU]    [Simultaneous Recording]  Desired photo quality* (top row)** 
 Desired photo size* (bottom row)  [X]

* The number displayed on the right corner indicates the approximate number of photos that can be recorded with the current quality/size setting.

** Touch  if you do not intend to use simultaneous recording.

Operating modes:    |  





While recording, or in record pause mode, press  to capture the photo.

In  mode, the size/quality of photos taken while recording video (simultaneous recording) will be determined by the setting selected with this procedure; the size/quality of photos taken in record pause mode will be determined by the photo size set in  mode ( 109).

IMPORTANT

- When recording photos on an Eye-Fi card in memory card slot **B**, photos will be uploaded automatically if you are within the range of a configured network. Always verify that Eye-Fi cards have been approved in the country/region of use. See also *Using an Eye-Fi card* ( 150).

NOTES

- Photo quality will be higher when photos are recorded in  mode or in  mode during record pause.
- Photos will be recorded on the memory selected for recording photos.
- Photos cannot be recorded simultaneously while the digital zoom or a digital effect is activated.
- Photos cannot be recorded simultaneously at [LW 3264x1840] size while the digital tele-converter ( 80) is activated.
- If while recording video, photos are recorded simultaneously at [LW 3264x1840] size, you may notice a very brief stop during the playback of the video at the point where  was pressed.

Light Metering Mode

The camcorder measures the light reflected from the subject in order to calculate the optimal exposure settings. Depending on the subject, you may want to change the way the light is measured and evaluated.

Operating modes:    |  

POINTS TO CHECK

- Select a recording program other than the Special Scene recording programs.

 [FUNC.] ➤ [Metering Mode] ➤ Desired option ➤ [X]

Options (♦ Default value)

 **Evaluative**♦ Appropriate for standard shooting conditions, including backlit scenes. The camcorder divides the picture into several areas and the light is measured in all of them to achieve the optimal exposure for the subject.

 **Center-Wt. Avg.** Averages the light metered from the entire screen, giving more weight to the subject in the center.

 **Spot** Meters only the area within the spot AE point frame. Use this setting to adjust the exposure to match the subject in the center of the screen.

Slideshow

You can play a slideshow of all the photos and even set it to music.



Operating modes:    |  

- 1 Open the [Photos] index screen.
- 2 Select the background music to use when playing back the photo slideshow ( 93).







Slideshow set to a music track

- 3 Touch the screen to display the playback controls, then touch [] to play back the slideshow set to the selected music track.

Slideshow not linked to the external audio

- 3 Touch the screen to display the playback controls, then touch [] to start the slideshow.
- 4 Start the music playback on the external player.
 - Drag your finger left and right along the volume bar to adjust the volume.
 - Touch [] to stop the slideshow. Hide the playback controls if necessary.

To change the slideshow's transition effects

 [MENU]    [Slideshow Transition] 
[Off], [Dissolve] or [Slide Image]  []

Magnifying Photos during Playback

In single photo view, photos can be magnified up to 5 times.  will appear for photos that cannot be enlarged.

Operating modes:    |  

1 Move the zoom lever toward **T**.

- The photo is magnified by 2 times and a frame appears indicating the position of the magnified area.
- To further enlarge the photo, move the zoom lever toward **T**. To reduce the magnification times, move it toward **W**.



2 Drag your finger across the photo to display the area you want to see enlarged.





To cancel the magnification, move the zoom lever toward **W** until the frame disappears.

Rotating Photos

You can rotate photos 90 degrees to change their orientation.

Operating modes:    |  

- 1 In single photo view, select the photo you want to rotate.
- 2 Touch the screen to display the playback controls.
- 3 Rotate the photo.

 [Edit]  [Rotate]  [] (90° left) or [] (90° right)

- 4 Drag your finger left/right to select another photo to rotate or touch .

Histogram Display

In single photo view, you can display the histogram and the icons of all the functions used at the time of recording (Exif information panel). The histogram will be displayed also immediately after taking a photo. Use the histogram as a reference to verify the correct exposure of the photo.

Operating modes:    |  

* In  mode the histogram will be displayed while a photo is reviewed immediately after having taken the photo.

Touch the screen to display the playback controls.

The histogram and Exif information panel are displayed as well. Press **[DISP.]** to hide the histogram and Exif information panel.

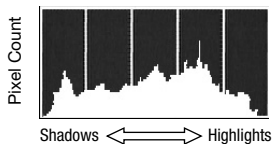

The area to the right of the histogram represents highlights and the left side represents shadows. A photo whose histogram skews to the right is relatively bright; while one whose histogram peaks to the left, is relatively dark.

Protecting Photos

You can protect photos from accidental erasure.

Operating modes:    |  

Protecting Single Photos

- 1 In single photo view, select the photo you want to protect.
- 2 Touch the screen to display the playback controls.

3 Protect the photo.

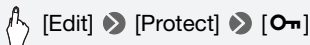

- appears and the photo cannot be deleted. Touch again to remove the protection.

4 Drag your finger left/right to select another photo to protect or touch [X].

Protecting Photos from the Index Screen

1 Open the [Photos] index screen.

2 Touch [] to open the photo selection screen.

3 Touch on the individual photos you want to protect.

- A checkmark will appear on photos selected. Touch a selected photo again to remove the checkmark.
- To select all the photos at once: Touch [Select All] instead of touching individual photos. (Remove in advance any checkmarks from photos you may have selected individually.)

4 Protect the photos.

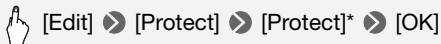

* Touch [Remove Protection] to remove the protection from the selected photos.

IMPORTANT

- Initializing the memory will permanently erase all recordings, including protected photos.

You can also use the following functions...

The following functions and features of the camcorder can be used either for shooting video or for taking photos. The way to set and use them was already explained in detail, so we refer you to the relevant page in the “Video” section.

- Zoom (📖 46)
- Quick Start (📖 47)
- Recording programs (📖 61, 63, 71)
- Face detection (📖 67)
- Touch & Track (📖 68)
- Digital effects (📖 70)
- Manual exposure adjustment (📖 74)
- Manual focus adjustment (📖 76)
- White balance (📖 79)
- Image effects (📖 81)
- Mini video light (📖 82)
- Self timer (📖 83)

Printing Photos

Printing Photos (Direct Print)

The camcorder can be connected to any PictBridge-compatible printer. You can mark in advance the photos you want to print and set the desired number of copies as a print order (📖 123).

Canon printers: SELPHY printers of the CP, DS and ES series and PIXMA printers carry the PictBridge logo.



Operating modes:



Connecting the Camcorder to the Printer



- 1 In single photo view, select a photo you want to print.
- 2 Turn on the printer.
- 3 Connect the camcorder to the printer using the supplied USB cable.
 - Connection [4]. Refer to *Connection Diagrams* (📖 128).
 - If the device selection screen appears, touch [Computer/Printer].
 - ⏪ appears and changes to 📷.

! IMPORTANT

- If ⏪ continues to flash (for more than 1 minute) or if 📷 does not appear, the camcorder is not correctly connected to the printer. In such case, disconnect the USB cable and turn off the camcorder and the printer. After a short while, turn them on again, set the camcorder to 📷 mode and restore the connection.
- During the following operations, even if you connect a printer to the camcorder it will not be recognized.
 - Deleting all photos
 - Removing all print orders

i NOTES

- 📷 will appear for photos that cannot be printed.
- We recommend powering the camcorder using the compact power adapter.

- Refer also to the printer's instruction manual.
- If you have no intention to use the optional DW-100 DVD Burner, you can set   [USB Connection Type] to  Computer/Printer] so the device type selection screen does not appear every time you connect the camcorder to a printer.
- For best performance when connecting the camcorder to a PictBridge-compatible printer, we recommend keeping the number of photos in the memory to no more than 100 photos.

Printing a Single Photo

With the camcorder correctly connected to the printer and the photo you want to print displayed in single photo view:



- Printing starts. When the printer finishes printing the photo, the camcorder will return to single photo view.
- Touch [Stop]  [Yes] to interrupt the printing in progress.
- Drag your finger left/right to select another photo to print.

To change the paper size



NOTES

- Print setting options and the [Default] paper size vary depending on the printer used. For details, refer to your printer's instruction manual.

When you have finished printing

Disconnect the USB cable from the camcorder and printer and turn off the camcorder.

Print errors

If an error occurs while printing, an error message (for example, [No paper]) will appear on the camcorder's screen. Solve the problem refer-

ring to the error message list (📖 191) and to the printer's instruction manual.

- **Canon's PictBridge-compatible printers:** If printing does not resume automatically after you solved the problem, touch [Continue] to resume printing. If that option is not available, touch [Stop] and then restart printing from the beginning.
- **Other printers or if the error still persists with a Canon printer:** If printing does not resume automatically, disconnect the USB cable and turn off the camcorder. After a short while, turn on the camcorder and restore the USB connection.

Print Orders

You can mark in advance photos you want to print from those recorded on a memory card, and set the desired number of copies as a print order. Later, you can easily print out the print orders by inserting the memory card into the SD memory card slot of DPOF-compatible printers or self-served digital photo kiosks. You can set print orders for up to 998 photos.

Operating modes:    |  

Marking Single Photos with Print Orders

- 1 In single photo view, select the photo you want to mark with a print order.

Check that you are viewing photos recorded on a memory card. (A) or (B) appears next to the photo number.)

- 2 Touch the screen to display the playback controls.
- 3 Mark the photo with a print order.

 [Edit] ➤ [Print Orders] ➤ [▲] or [▼] to set the number of copies ➤ [Set]

- The total number of copies in the DPOF print order appears next to the 📄 icon.
 - To cancel the print order, set the number of copies to 0.
- 4 Drag your finger left/right to select another photo to mark with a print order or touch [X].

Setting Print Orders from the Index Screen

1 Open the [Photos] index screen.

Check that you have selected the [A] or [B] tab (memory card [A] or [B]).

2 Touch [☑] to open the photo selection screen.

3 Touch on the individual photos you want to mark with a print order.

- A checkmark ✓ will appear on photos selected. Touch a selected photo again to remove the checkmark.
- To select all the photos at once: Touch [Select All] instead of touching individual photos. (Remove in advance any checkmarks from photos you may have selected individually.)

4 Mark the photos with print orders.



[Edit] ➤ [Print Orders] ➤ Desired option ➤ [OK]

Options

[One Copy Each] Sets a print order of 1 copy of each of the selected photos.

[Remove Print Orders] Removes all the print orders from the selected photos.

NOTES

- **HFS21/S20** To set print orders for photos recorded in the built-in memory, copy the photos to memory card [B] in advance.



External Connections

This chapter explains how to connect your camcorder to an external device such as a TV, VCR, or computer.

Terminals on the Camcorder

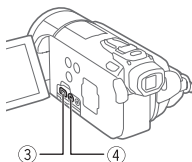
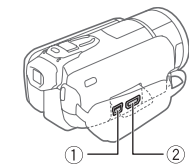

① USB Terminal

Access: Open the side terminal cover.



② HDMI OUT Terminal*

Access: Open the side terminal cover.

The HDMI OUT terminal offers a high-quality digital connection that combines audio and video in a single convenient cable.



③ COMPONENT OUT Terminal*

Access: Open the LCD panel and terminal cover.

The component video terminal is for video only.

When you use connection ② do not forget the audio connections using the AV OUT/⌚ terminal.



④ AV OUT/⌚ Terminal

Access: Open the LCD panel and terminal cover.

Sound from the built-in speaker will be muted while the STV-250N Stereo Video Cable is connected to the camcorder. Adjust the volume on the connected TV.

* When connecting a cable to the camcorder, make sure to align the cable so the triangle mark on the connector is facing up.

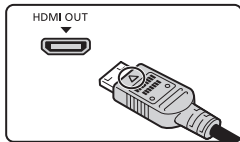
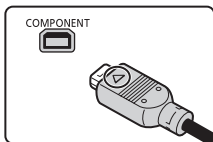

Connection Diagrams

In the following connection diagrams, the left side shows the terminals on the camcorder and the right side shows (for reference only) an example of terminals on a connected device.

Connection 1

HDMI

Type: Digital • Quality: High definition • Output only

Connect to a high-definition TV (HDTV) with an HDMI input terminal.

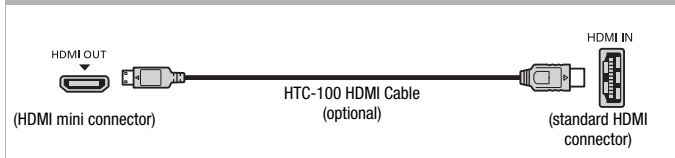

About the HDMI™ connection

The HDMI (High-Definition Multimedia Interface) connection (1) is a convenient all-digital connection using a single cable for both video and audio. When you connect the camcorder to an HDTV equipped with an HDMI terminal, you can enjoy video and audio playback at the highest quality.

- The HDMI OUT terminal on the camcorder is for output only. Do not connect it to an HDMI output terminal on an external device, as this may damage the camcorder.
- While the camcorder is connected to an HDTV using connection 1, there will be no video output from other terminals.
- Correct operation cannot be guaranteed when connecting the camcorder to DVI monitors.
- Depending on the HDTV, correct playback of personal video content may not be possible using connection 1. Try one of the other connections.

Connection 2

Component Video

Type: Analog • Quality: High Definition • Output only

Connect to a high-definition TV (HDTV) with component video input terminals. Change the following settings on the camcorder:

-   [AV/Headphones] to [**AV** AV]

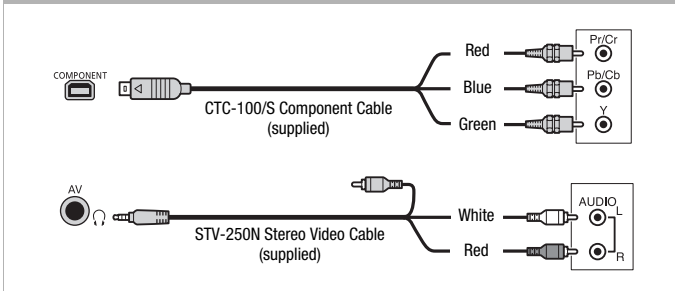





Connection 3

Composite Video

Type: Analog • Quality: Standard definition • Output only

Connect to a standard TV or a VCR with audio/video input terminals. Change the following settings on the camcorder:

-   [TV Type] according to the TV set (widescreen or 4:3), if the TV cannot automatically detect and change the aspect ratio
-   [AV/headphones] to [**AV** AV]

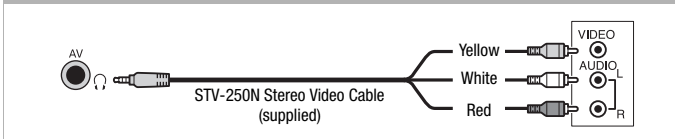

Type: Digital data connection

Connect to a computer to save your recordings, to the optional DW-100 DVD Burner to create DVD discs from them, or to a printer to print out photos.

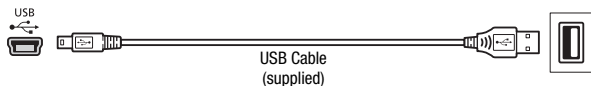
**i** NOTES

- To be able to write back scenes and to transfer music files from the computer to the camcorder, power the camcorder using the compact power adapter and only then connect it to the computer using the supplied USB cable.

Playback on a TV Screen

Connect the camcorder to a TV to enjoy your recordings with family and friends. Playback on an HDTV using one of the high-definition connections will ensure the best playback quality.



Operating modes:    |  

1 Turn off the camcorder and the TV.**2 Connect the camcorder to the TV.**

Refer to *Connection Diagrams* (📖 126) and select the most appropriate connection for your TV.



3 Turn on the connected TV.

On the TV, select as the video input the same terminal to which you connected the camcorder. Refer to the instruction manual of the connected TV.

4 Turn on the camcorder and set it to  or  mode.

Play back the movies or photos.

NOTES

- To correctly play back movies recorded with x.v.Color ( 162) on an HDTV compatible with this standard, additional settings may be required on the connected HDTV. Refer to the TV's instruction manual.
- We recommend powering the camcorder using the compact power adapter.
- Connection : When you play back your 16:9 movies on standard TV sets with a 4:3 aspect ratio, the TV set will switch automatically to wide-screen mode if it is compatible with the Video ID-1 system. Otherwise, change the aspect ratio of the TV manually.

Saving and Sharing Your Recordings

Copying Recordings to a Memory Card

You can copy your recordings only one-way: from the built-in memory or from memory card **A** to memory card **B**. Scenes and photos will be copied from the index screen you selected to the corresponding index screen on the memory card.

Please read the IMPORTANT section (📖 132) before using an Eye-Fi card.



POINTS TO CHECK

- Make sure the memory card to which you want to copy recordings is inserted into memory card slot **B**.

Copying Scenes

Operating modes:



1 Open the index screen that contains the scenes you want to copy.

- Select the tab to copy scenes from the built-in memory (**HFS21/S20** only) or the **A** tab to copy scenes from memory card **A**.
- [Original] or [Video Snapshot] → [Original] index screen: To copy all the scenes recorded on a specific date, narrow down the scenes shown to scenes recorded on that date (📖 56).

2 Touch to open the scene selection screen.

When you copy scenes from the [Playlist] index screen (including the playlist of video snapshot scenes), you cannot select individual scenes; instead, the entire playlist will be copied. Skip directly to step 4.

3 Touch on the individual scenes you want to copy.

- A checkmark will appear on scenes selected. Touch a selected scene again to remove the checkmark.
- To select all the scenes at once: Touch [Select All] instead of touching individual scenes. (Remove in advance any checkmarks from scenes you may have selected individually.)

4 Copy the scenes.



 [Edit] ➤ [Copy ( ➤ )] (HFS21/S20 only) or [Copy ( ➤ )] ➤ [Yes]* ➤ [OK]

* Touch [Stop] to interrupt the operation while it is in progress.

Copying a Single Photo







Operating modes:    |  

1 In single photo view, select the photo you want to copy.

Check that you are viewing photos recorded in the built-in memory (HFS21/S20 only) or on memory card . ( or  appears next to the photo number.)

2 Touch the screen to display the playback controls.

3 Copy the photo.



 [Edit] ➤ [Copy ( ➤ )] (HFS21/S20 only) or [Copy ( ➤ )] ➤ [ Proceed] ➤ [Yes]

4 Drag your finger left/right to select another photo to copy or touch [X].

Copying Photos from the Index Screen

Operating modes:    |  

1 Open the [Photos] index screen.

Select the  tab to copy photos from the built-in memory (HFS21/S20 only) or the  tab to copy photos from memory card .

2 Touch [] to open the photo selection screen.

3 Touch on the individual photos you want to copy.

- A checkmark ✓ will appear on photos selected. Touch a selected photo again to remove the checkmark.
- To select all the photos at once: Touch [Select All] instead of touching individual photos. (Remove in advance any checkmarks from photos you may have selected individually.)

4 Copy the photos.



* Touch [Stop] to interrupt the operation while it is in progress.

! IMPORTANT

- Observe the following precautions while the ACCESS indicator is on or flashing. Failing to do so may result in permanent data loss.
 - Do not open the double memory card slot cover.
 - Do not disconnect the power source or turn off the camcorder.
 - Do not change the camcorder's operating mode.
- When copying photos onto an Eye-Fi card in memory card slot **B**, photos will be uploaded automatically if you are within the range of a configured network. Always verify that Eye-Fi cards have been approved in the country/region of use. See also *Using an Eye-Fi card* (📖 150).

i NOTES

- In the following cases, you will not be able to copy recordings to the memory card:
 - If the double memory card slot is open.
 - If the LOCK switch on memory card **B** is set to prevent writing.
 - If there is no memory card in memory card slot **B**.
- Scenes that were edited using the supplied software **ImageMixer 3 SE** and were then written back to the camcorder cannot be copied to the memory card.
- If there is not enough space on memory card **B**, as many photos as possible will be copied before stopping the operation.

Saving Recordings on a Computer

Movies recorded with this camcorder are saved in the built-in memory (**HFS21/S20** only) or on the memory cards. Because space is limited, make sure to save your recordings on a computer on a regular basis.

Saving Movies

With the supplied software **ImageMixer 3 SE** you can save scenes to your computer. If necessary, video files previously saved on a computer can be restored back to the camcorder. The software also offers many options for organizing your video library, editing video and more.

Installation

See 'PIXELA Applications' Installation Guide.

Using the software

See 'ImageMixer 3 SE Software Guide' (PDF file).

Saving Photos

With the supplied software **Photo Application** you can save photos to your computer, and easily organize and edit them.

Installation

Install the software before you connect the camcorder to the computer for the first time. See also the relevant sections in the 'Photo Application' Instruction Manual (**PHOTO** PDF file) in the [MANUALS_ENGLISH] folder on the supplied Camcorder Supplemental Disc.

Install the supplied Photo Application software following the instructions in the software's instruction manual.



PHOTO Refer to *Installing Photo Application*.

First-time connection to a computer running Windows

Windows users only: The first time you connect the camcorder to the computer, you also need to select the CameraWindow auto-launch setting.

 Refer to *Starting CameraWindow*.

Using the software

- 1 Power the camcorder using the compact power adapter.
- 2 Set the camcorder to  mode, in single photo view.
- 3 Connect the camcorder to the computer using the supplied USB cable.
 - Connection  4. Refer to *Connection Diagrams* ( 128).
 - If the device type selection screen appears, touch [Computer/Printer].
- 4 Save the photos onto the computer.

 Refer to *Downloading Still Images to the Computer*.

IMPORTANT

- **When the camcorder is connected to a computer:**
 - Do not open the double memory card slot cover and do not remove the memory cards.
 - Do not access, change or delete any of the camcorder's folders or files directly from the computer as this may result in permanent data loss. Always save your movies on the computer, and restore files to the camcorder, using only the supplied software **ImageMixer 3 SE**.
- Operation may not work correctly depending on the software and the specifications/settings of your computer.
- If you wish to use the image files on your computer, make copies of them first. Use the copied files, retaining the originals.
- Observe the following precautions while the ACCESS indicator is on or flashing. Failing to do so may result in permanent data loss.
 - Do not open the double memory card slot cover.
 - Do not disconnect the USB cable.
 - Do not turn off the camcorder or the computer.
 - Do not change the camcorder's operating mode.

- When restoring to the camcorder video files that were previously saved to the computer, do not disconnect the USB cable or turn off the camcorder or computer. Doing so may result in scenes that cannot be played back on the camcorder.

NOTES

- Refer also to the computer's instruction manual.
- **Users of Windows 7, Windows Vista, Windows XP and Mac OS X:** Your camcorder is equipped with the standard Picture Transfer Protocol (PTP) allowing you to transfer photos (JPEG only) simply by connecting the camcorder to a computer using the supplied USB cable, without having to install the supplied software **Photo Application**.
- If you have no intention to use the optional DW-100 DVD Burner, you can set   [USB Connection Type] to  [Computer/Printer] so the selection screen does not appear every time you connect the camcorder to a computer.
- If you connect the camcorder to the computer while it is set to  mode, the process of creating scene thumbnails will start automatically. If your intention was to save photos to the computer, you can touch [Skip] to stop the process and use the computer's Safely Remove Hardware function (Windows) or Eject function (Mac OS) to end the connection to the camcorder. Disconnect the USB cable, set the camcorder to  mode and restore the connection.

Saving Movies onto High-Definition Discs (AVCHD/Blu-ray Discs)

You can save your video recordings in high definition by creating AVCHD or Blu-ray discs in your computer using the supplied software **ImageMixer 3 SE**.

Installation

See 'PIXELA Applications' Installation Guide.

Using the software

See 'ImageMixer 3 SE Software Guide' (PDF file).

Even without a computer, you can save your video recordings in high definition by creating AVCHD discs using the optional DW-100 DVD Burner. Refer to this section along with the relevant sections in the instruction manual of the DW-100.



Operating modes:    |  

Preparations on the Camcorder

- 1 **Power the camcorder using the compact power adapter.**
- 2 **Open the [Original], [Playlist] or [Video Snapshot] → [Original]/[Playlist] index screen.**





AVCHD discs created with the optional DW-100 DVD Burner cannot contain scenes recorded in MXP mode. If you have recorded scenes in MXP mode, add to the playlist in advance only those scenes recorded in other recording modes and create the disc from the [Playlist] index screen.
- 3 **For original recordings only: Choose whether to add to the disc all the scenes or only scenes that have not been previously added to a disc.**

When you create the disc from the [Playlist] index screen (including the playlist of video snapshot scenes), the disc will contain the entire playlist.

 [MENU] ➤  ➤ [Add Recordings to Disc] ➤
[All Scenes] or [Remaining Scenes] ➤ [X]

Connecting to the DW-100 DVD Burner and Creating AVCHD Discs

- 1 **Turn on the DVD Burner.**

 Refer to *Creating DVDs*.
- 2 **Connect the camcorder to the DVD Burner using the supplied USB cable.**
 - Connection . Refer to *Connection Diagrams* ( 128) and  *Connections*.
 - If the device type selection screen appears, touch [DVD Burner].
 - When the connection is completed, [No disc] will be displayed.

3 Insert a brand new disc into the DVD Burner.

- Use the OPEN/CLOSE button on the DVD Burner to open and close the disc tray.
- After the disc is recognized, an information screen will display the type of DVD you are creating and the estimated time and number of discs it will require (based on the disc you inserted).
- If you inserted a DVD-RW disc that already contains data, [The disc already contains data.] will be displayed. To overwrite the data (erasing the previous content of the disc), touch [OK]  [Yes].

4 Press the start button on the DVD Burner.

- A progress bar will be displayed on the screen.
- After pressing the start button (while the disc is being written) the operation cannot be canceled.
- When the last disc is finalized, [Task completed] will be displayed. Take out the disc and close the disc tray.

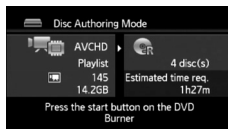

When the data requires multiple discs

After a disc is finalized, it will be ejected automatically and a message will appear. Insert the next disc and close the disc tray.

To create an additional copy of the same disc

After the operation is finished, insert a brand new disc, close the disc tray and repeat the operation.

IMPORTANT

- AVCHD discs created with the optional DW-100 DVD Burner cannot contain scenes recorded in MXP mode. Use the supplied software **ImageMixer 3 SE** to save such scenes.
- While the camcorder is connected to the DVD Burner, do not open the double memory card slot cover and do not remove the memory cards.

- Observe the following precautions while the ACCESS indicator on the camcorder is on or flashing. Failing to do so may result in permanent data loss.
 - Do not open the double memory card slot cover.
 - Do not disconnect the USB cable.
 - Do not disconnect the compact power adapter or turn off the camcorder or the DVD Burner.
- For important information on handling your discs, refer to [DW-100](#) > *Cautions on handling*.

i NOTES

- If a scene does not fit entirely in one disc, it may be divided and continue on the next disc.
- When the camcorder contains a large number of scenes to be saved on discs, it may take a long time for the connection to the DVD Burner (step 2 above) to be completed. For best performance, we recommend limiting the number of scenes to be saved to 500 or fewer scenes. (With 500 scenes, it will take approximately 3 minutes to complete the connection.)

Playing back AVCHD discs created with the DW-100 DVD Burner

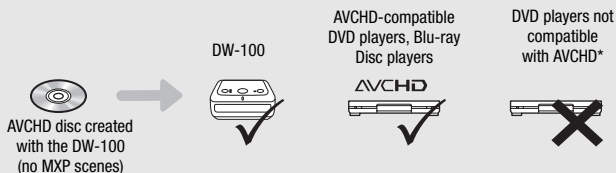

* Do not insert a disc into an incompatible device, as you may not be able to eject the disc.

Playing Back AVCHD Discs Using the DW-100 DVD Burner

You can use the optional DW-100 DVD Burner and the camcorder also to play back high-definition (AVCHD) discs on a TV. This is very convenient, for example to play back your discs even in a location where an AVCHD-compatible DVD player is not available.

Operating modes: |

1 Connect the camcorder to the TV.

Refer to *Connection Diagrams* (📖 126). Select connection 1 or 2 to enjoy high-definition playback.

2 Turn on the camcorder and set it to mode.

3 Turn on the DVD Burner and set it to Disc Playback mode.

 Refer to *Playing DVDs*.

4 Connect the camcorder to the DVD Burner using the supplied USB cable.

- Connection 4. Refer to *Connection Diagrams* (📖 128) and  *Connections*.
- If the device type selection screen appears, touch [DVD Burner].

5 Insert the disc you want to play back into the DVD Burner.

- Use the OPEN/CLOSE button on the DVD Burner to open and close the disc tray.
- After the disc is recognized, the disc's content will be displayed in an index screen.

6 Select the scene you want to play back and touch it to start playing it back.

IMPORTANT

- While the camcorder is connected to the DVD Burner, do not open the double memory card slot cover and do not remove the memory cards.

NOTES

- Only AVCHD discs created with the DW-100 DVD Burner can be played back using the DVD Burner.
- The camcorder's menus cannot be accessed while the camcorder is connected to the DVD Burner.
- With the exception of fast playback at 60x speed, special playback modes (📖 49) can be used also for disc playback.

Saving Movies onto Standard-Definition Discs (DVD)

You can convert your high-definition video recordings into standard definition and save them onto standard DVDs. These are ideal for sharing your videos with family and friends since, unlike AVCHD or Blu-ray discs, standard DVDs can be played back on most DVD players and computers' DVD drives.

You can complete the conversion to standard definition in the camcorder and then use the supplied software **ImageMixer 3 SE** to save the converted scenes and burn them onto DVDs in your computer.

Installation

See 'PIXELA Applications' Installation Guide.



Using the software

See 'ImageMixer 3 SE Software Guide' (PDF file).

Even without a computer, you can convert your video recordings into standard definition scenes and create DVDs using the optional DW-100 DVD Burner. Refer to this section along with the relevant sections in the instruction manual of the DW-100.

Operating modes:    |  

Converting Scenes into Standard Definition

- 1 Power the camcorder using the compact power adapter.
- 2 Make sure there is a memory card in slot **B** with sufficient available space.
- 3 Open the [Original], [Playlist] or [Video Snapshot] → [Original]/[Playlist] index screen.
 - Select the  tab to convert scenes from the built-in memory (HFS21/S20 only) or the  **A** tab to convert scenes from memory card **A**.
 - [Original] or [Video Snapshot] → [Original] index screen: To convert all the scenes recorded on a specific date, narrow down the scenes shown to scenes recorded on that date ( 56).

4 Touch to open the scene selection screen.

When you convert scenes from the [Playlist] index screen (including the playlist of video snapshot scenes), you cannot select individual scenes; instead, the entire playlist will be converted. Skip directly to step 6.

5 Touch on the individual scenes you want to convert.

- A checkmark ✓ will appear on scenes selected. Touch a selected scene again to remove the checkmark.
- To select all the scenes at once: Touch [Select All] instead of touching individual scenes. (Remove in advance any checkmarks from scenes you may have selected individually.)

6 Touch [Edit] [Convert HD→SD (DVD)] to open the HD→SD conversion screen.

- If a copyright notice appears, read it carefully and touch [OK] if you agree.
- touch  to change the conversion settings as described below.

7 Touch [Yes] [OK].

Touch  to interrupt the operation while it is in progress.

To embed the recording date and time

The recording date and time will always be displayed on the converted scene.

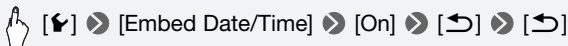

To select the bit rate

Using a higher bit rate will result in better video quality for the converted scenes.

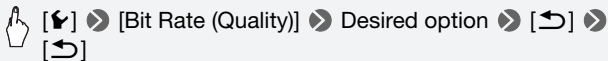

NOTES

- **When converting scenes in the [Playlist] or [Video Snapshot] → [Original]/[Playlist] index screen:**
 - The scenes are converted with the selected background music ( 93) instead of the original sound.

- **When converting scenes in the [Playlist] index screen:**
 - All the scenes are merged into one converted scene.
 - If the converted scene is too large, it will be split into 2 GB-sized scenes.
 - The playlist cannot be converted when its total playback time exceeds 2 hours and 30 minutes.
- The time required to convert scenes is approximately equal to the total playback time of the converted scenes. In most cases this is still faster than converting the scenes in the computer so we recommend you convert scenes in the camcorder.

Connecting to the Computer and Creating DVD Discs

- 1 **Power the camcorder using the compact power adapter.**
- 2 **Open the [For DVD Burning] index screen on memory card **B**.**



- 3 **Connect the camcorder to the computer using the supplied USB cable.**
 - Connection **4**. Refer to *Connection Diagrams* (□ 128).
 - If the device type selection screen appears, touch [Computer/Printer].
 - On the computer, ImageMixer 3 SE will start up automatically and the startup screen (ImageMixer 3 Launcher) will appear.
- 4 **Click [Disc writing] and continue the operation on the computer following the software's indications.**
See also 'ImageMixer 3 SE Software Guide' (PDF file).

! IMPORTANT

- While the camcorder is connected to the computer, do not open the double memory card slot cover and do not remove the memory cards.

- Observe the following precautions while the ACCESS indicator is on or flashing. Failing to do so may result in permanent data loss.
 - Do not open the double memory card slot cover.
 - Do not disconnect the USB cable.
 - Do not disconnect the compact power adapter or turn off the camcorder or the computer.



Connecting to the DW-100 DVD Burner and Creating DVD Discs

Operating modes:    |  

- 1 Power the camcorder using the compact power adapter.
- 2 Open the [For DVD Burning] index screen on memory card **B**.

 [] > [**B**] > [SD Scenes] > [For DVD (SD-VIDEO)]

- 3 In  mode: Choose whether to add to the disc all the scenes or only scenes that have not been previously added to a disc.

 [MENU] >  [Add Recordings to Disc] > [All Scenes] or [Remaining Scenes] > [X]

- 4 Connect the camcorder to the DW-100 DVD Burner and create the disc.

The procedure is the same as that for burning AVCHD discs ( 136).

To play back standard-definition DVDs

Standard-definition DVDs are created using DVD-Video specifications. Play back these DVDs using standard DVD players.

NOTES

- When the camcorder contains a large number of scenes to be saved on discs, it may take a long time for the connection to the DVD Burner ( 136, step 2) to be completed. For best performance, we recommend limiting the number of scenes to be saved to 500 or fewer scenes.

- Standard-definition DVDs cannot be played back using the DW-100 DVD Burner.

Saving Photos on Photo DVDs

Using the optional DW-100 DVD Burner you can save your photos on a Photo DVD. The Photo DVD will contain all your photos as JPG files as well as a slideshow of all the photos, each displayed for about 3 seconds, with the selected background music (📖 93).

Refer to this section along with the relevant sections in the instruction manual of the DW-100.

Operating modes:   |  

- 1 Power the camcorder using the compact power adapter.
- 2 Open the [Photos] index screen.
- 3 Connect the camcorder to the DW-100 DVD Burner and create the disc.

The procedure is the same as that for burning AVCHD discs (📖 136).

To play back Photo DVDs

Photo DVDs are created using DVD-Video specifications. Play back these DVDs using standard DVD players. If your computer has a DVD drive, you can play back the slideshow as a DVD and you can also access individual photos as JPG files.

NOTES

- Photo DVDs cannot be played back using the DW-100 DVD Burner.
- When creating Photo DVDs from a memory card, if the memory card contains SD scenes in the [For Web Upload] index screen, the image files of the scene thumbnails will be saved on the DVD as well.

Copying Recordings to an External Video Recorder

In High Definition



Connect the camcorder to AVCHD-compatible digital video recorders to make perfect copies of your movies in high definition. If the external digital video recorder has an SD memory card slot, you can use the memory card to copy your movies without connecting the camcorder. Details will vary depending on the device used so be sure to refer to the instruction manual of the digital video recorder.

In Standard Definition







You can copy your movies by connecting the camcorder to a VCR or a digital video recorder with analog audio/video inputs. Video output will be in standard definition, although the original scenes are in high definition.

Operating modes:    |  

Connecting

Connect the camcorder to the VCR using Connection . Refer to *Connection Diagrams* ( 127).

Recording

- 1 External device: Load a blank cassette or disc and set the device to record/pause mode.**
- 2 Turn on the camcorder and set it to  mode.**
Verify that   [AV/Headphones] is set to [ AV].
- 3 Camcorder: Locate the scene you wish to copy and pause the playback shortly just before the desired scene.**
- 4 Camcorder: Resume playback.**
By default, onscreen displays will be embedded in the output video signal. You can change the displays by repeatedly pressing  ( 97).
- 5 External device: Start recording when the scene you wish to copy appears; stop recording when it ends.**
- 6 Camcorder: Stop playback.**

NOTES

- We recommend powering the camcorder using the compact power adapter.

Uploading Movies to Video Sharing Web Sites

You can convert your high-definition video recordings into standard definition in order to upload them to your favorite video sharing Web site.

If you are using an Eye-Fi card, after converting your video recordings into standard definition scenes you can upload your movies wirelessly, directly from the camcorder. Refer to Eye-Fi's homepage for the latest information on compatible Web sites.

You can complete the conversion to standard definition in the camcorder and then use the supplied software **ImageMixer 3 SE** to upload your videos to the Web.

Installation

See 'PIXELA Applications' Installation Guide.

Using the software





See 'ImageMixer 3 SE Software Guide' (PDF file).

Operating modes:    |  

Converting Scenes into Standard Definition

- 1 **Power the camcorder using the compact power adapter.**
- 2 **Make sure there is a memory card in slot **B** with sufficient available space.**

3 Open the [Original], [Playlist] or [Video Snapshot] → [Original]/[Playlist] index screen.

- Select the  tab to convert scenes from the built-in memory (HFS21/S20 only) or the  tab to convert scenes from memory card .
- [Original] or [Video Snapshot] → [Original] index screen: To convert all the scenes recorded on a specific date, narrow down the scenes shown to scenes recorded on that date ( 56).



4 Touch to open the scene selection screen.

When you convert scenes from the [Playlist] index screen (including the playlist of video snapshot scenes), you cannot select individual scenes; instead, the entire playlist will be converted. Skip directly to step 6.

5 Touch on the individual scenes you want to convert.

- A checkmark  will appear on scenes selected. Touch a selected scene again to remove the checkmark.
- To select all the scenes at once: Touch [Select All] instead of touching individual scenes. (Remove in advance any checkmarks from scenes you may have selected individually.)

6 Press and touch [Yes].

- If a copyright notice appears, read it carefully and touch [OK] if you agree.
- Before touching [Yes], you can touch  to change the conversion settings as described below.
- Touch  to interrupt the operation while it is in progress.

7 When the conversion is completed, a confirmation screen will appear.

Connect the camcorder to the computer at this point ( 149) to continue uploading the converted videos to the Web or touch [End Without Connecting] to connect to the computer later.

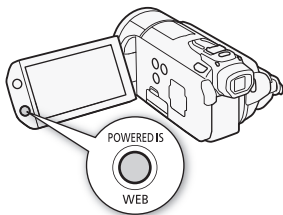

To embed the recording date and time

The recording date and time will always be displayed on the converted scene.

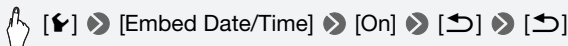

To select the bit rate

Using a higher bit rate will result in better video quality for the converted scenes, while a lower bit rate will result in smaller file sizes and faster uploads.

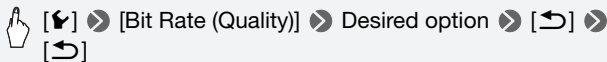

To convert only part of a scene

Instead of steps 4 and 5 above, touch on the scene you want to convert to start playing it back. Pause the playback at the point where you want the conversion to begin and continue with step 6.

NOTES

- **When converting scenes in the [Playlist] or [Video Snapshot] → [Original]/[Playlist] index screen:**
 - The scenes are converted with the selected background music (📖 93) instead of the original sound.
- **When converting scenes in the [Playlist] index screen:**
 - All the scenes are merged into one converted scene.
 - If the converted scene is too large, it will be split into smaller 10-minute long scenes.
 - When converting only part of a scene, the maximum length of the converted scene will be 10 minutes from the starting (playback pause) point.
 - The playlist cannot be converted when its total playback time exceeds 2 hours and 30 minutes.
- The time required to convert scenes is approximately equal to the total playback time of the converted scenes. In most cases this is still faster than converting the scenes in the computer so we recommend you convert scenes in the camcorder.

Connecting to the Computer and Uploading your Videos

If you are connecting the camcorder to the computer immediately after the conversion described in the previous section, start this procedure from step 3 below. Otherwise, start this procedure from the beginning.

- 1 Power the camcorder using the compact power adapter.
- 2 Open the [For Web Upload] index screen on memory card **B**.

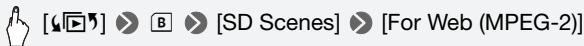

- 3 Connect the camcorder to the computer using the supplied USB cable.
 - Connection **4**. Refer to *Connection Diagrams* (📖 128).
 - If the device type selection screen appears, touch [Computer/Printer].
 - On the computer, ImageMixer 3 SE will start up automatically and the startup screen (ImageMixer 3 Launcher) will appear.
- 4 Click [Web upload] and continue the operation on the computer following the software's indications.

See also 'ImageMixer 3 SE Software Guide' (PDF file).

IMPORTANT

- While the camcorder is connected to the computer, do not open the double memory card slot cover and do not remove the memory cards.
- Observe the following precautions while the ACCESS indicator is on or flashing. Failing to do so may result in permanent data loss.
 - Do not open the double memory card slot cover.
 - Do not disconnect the USB cable.
 - Do not disconnect the compact power adapter or turn off the camcorder or the computer.

Uploading your Videos Wirelessly

If you are using an Eye-Fi card, you can automatically upload the movies from the [For Web Upload] index screen to your favorite video sharing Web site. You will need to have installed the software supplied with your Eye-Fi card and completed all the required configuration setup in advance. Refer to the instruction manual of the Eye-Fi card.

Please read the IMPORTANT section (📖 150) before using an Eye-Fi card.

1 Insert your Eye-Fi card into memory card slot **B and make sure there is sufficient available space on the memory card.**

2 Convert the desired movies (📖 146).

- When the conversion is completed, touch [End Without Connecting].
- If you are within the range of a configured network, Web upload will start automatically.
- The status of the wireless communication is shown by the Eye-Fi icon as follows:
 - 📶 (grayed out) Communication not established
 - 📶 (white, flashing) Connecting; 📶 (white, continuously on) Wireless upload on standby
 - 📶 (animated) Wireless upload in progress
 - 📶 [Eye-Fi Communication] is set to [**OFF** Off]
 - 📶 Wireless upload stopped by the camcorder (📖 181)
 - 📶 Error reading from the Eye-Fi card (📖 179)

IMPORTANT

Using an Eye-Fi Card

- This product is not guaranteed to support Eye-Fi card functions (including wireless transfer). In case of an issue with an Eye-Fi card, please check with the card manufacturer. Also note that an approval is required to use Eye-Fi cards in many countries or regions. Without approval, use of the card is not permitted. If it is unclear whether the card has been approved for use in the area, please check with the card manufacturer.
- Do not use Eye-Fi cards on airplanes and in other places where wireless communication is forbidden. Remove the Eye-Fi card from the camcorder beforehand.

NOTES

- Depending on the amount of data to be uploaded and the network's wireless connection conditions, it can take some time to upload video files. If the wireless connection is too weak, the wireless upload may fail and the video files will be registered as incomplete uploads.
- **About power saving:**
 - Wireless communication drains the power of the battery pack faster than usual. We recommend powering the camcorder using the compact power adapter.
 - While files are being uploaded wirelessly, the camcorder's automatic power off function will be disabled.
- While recording audio with an external microphone, the interference caused by wireless communications may result in noise being picked up and recorded with the sound. We recommend turning off the wireless communication while recording.



- If the LOCK switch on the Eye-Fi card is set to prevent writing, you will not be able to turn the wireless communication on/off and the status icon will change to . To use wireless communication make sure the switch on the Eye-Fi card is not in the LOCK position.
- While using an Eye-Fi Card, the ACCESS indicator may flash from time to time.
- Wirelessly uploading files is not possible when the Eye-Fi card is in memory card slot **A** (the Eye-Fi icon will not appear on the screen). Be sure to insert the Eye-Fi card into memory card slot **B**.



Additional Information

This chapter contains troubleshooting advice, screen messages, handling and maintenance tips, and other information.







































Appendix: Menu Options Lists

Menu items not available appear grayed out. For details about how to select an item, refer to *Using the Menus* (book 32). For details about each function, see the reference page. Menu options without a reference page are explained after the tables. Underlined menu options indicate default values.

FUNC. Panel

FUNC. Panel - Recording Modes

Control Button	Setting options/Function			
[MENU]	Open the menus	●	●	33
[Rec. Programs]	<u>[P Programmed AE]</u> , [Tv Shutter-Pri. AE], [Av Aperture-Pri. AE]	●	●	71
	[Cine Mode]	●	●	63
	[Portrait], [Sports], [Night Scene], [Snow], [Beach], [Sunset], [Low Light], [Spotlight], [Fireworks]	●	●	61
[WB White Balance]	<u>[AWB Automatic]</u> , [Daylight], [Shade], [Cloudy], [Fluorescent], [Fluorescent H], [Tungsten], [Custom WB]	●	●	79
[Mic. Level]	<u>[A Automatic]</u> , [M Manual] [Audio Level Indicator]: Toggle on (●) or off (○)	●	–	84
[Flash]	<u>[Flash Automatic]</u> , [Red-Eye Auto], [Flash On], [Flash Off]	–	●	111



Control Button	Setting options/Function			
[ Focus]	[MF] (manual focus): Toggle on () or off (), Touch AF frame, [PEAK] (peaking): Toggle on () or off (), [] (peaking settings): [Peaking and B&W]: [<u>Off</u>], [On] [Peaking Color]: [<u>Red</u>], [Blue], [Yellow]	●	●	76
[ Exposure]	[M] (manual exposure): Toggle on () or off (), Touch AE frame, [ 70], [ 100] (zebra pattern): Toggle on () or off (), [] (AE and zebra pattern settings): [AE Lock (touch)]: [<u>Normal</u>], [Highlights] [Zebra Pattern]: [<u>70%</u>], [100%]	●	●	74
[ZOOM]	Zoom controls, [<u>START/STOP</u>] control, [] (digital tele-converter): Toggle on () or off ()	●	●	46, 80
[ AGC Limit]	[A Automatic], [M Manual]: (0 dB - 24 dB)	●	–	76
[Metering Mode]	[ Evaluative], [] Center-Wt. Avg., [] Spot]	–	●	115
[ Video Light]	[ON On], [OFF Off]	●	●	82
[ Pre REC]	[ON On], [OFF Off]	●	–	66
[Drive Mode]	[] Single, [] AE Bracketing], [] Continuous], [] Hi-Speed Cont.]	–	●	113
[ Digital Effects]	[] Off], [E1 Black & White], [E2 Sepia], [F1 Fade Trigger/Once], [F1 Fade Trigger/Always], [F2 Wipe/Once], [F2 Wipe/Always]	●	–	70
	[] Off], [E1 Black & White], [E2 Sepia]	–	●	
[Image Stabilizer]	[] Dynamic], [] Standard], [] Off]	●	–	64
	[] On], [] Off]	–	●	











[Edit] Panel - Mode

: Original scenes

: Playlist scenes (including the playlist only of video snapshot scenes)

: Original video snapshot scenes

: SD scenes on memory card 





Control Button	Target Scenes/Function					
[Copy ( → )]  [Copy ( → )]	[Selected Scenes]	●	–	●	–	130
	[All Scenes]	●	●	●	–	
	[This Scene] (from the Timeline screen)	●	–	●	–	
[Convert HD → SD ( DVD)]	[Selected Scenes]	●	–	●	–	140
	[All Scenes]	●	●	●	–	
	[This Scene] (from the Timeline screen)	●	–	●	–	
[Delete]	[Selected Scenes]	●	–	●	–	57, 99
	[All Scenes]	●	●	●	●	
	[This Scene] (from the Timeline screen or playback pause)	●	●	●	–	
[Add to Playlist]	[Selected Scenes], [All Scenes]	●	–	●	–	98
	[This Scene] (from the Timeline screen)	●	–	●	–	
[Move]	[This Scene] (from the Timeline screen)	–	●	–	–	99
[Divide]	[This Scene] (from the Timeline screen or playback pause)	●	–	–	–	102

[Edit] Panel -  Mode

Control Button	Index Screen	Single Photo View	
[Copy (A → B)] HFS21/S20 [Copy (🖨️ → B)]	[Selected Photos], [All Photos]	●	131
[Delete]		●	106
[Protect]		●	118
[Print Orders]		●	123
[Rotate]	—	●	117

Setup Menus

/ Camera Setup

Menu item	Setting options			
[Digital Zoom]	[OFF Off], [40x 40x], [200x 200x]	●	–	–
[Zoom Speed]	[VAR Variable], [»»» Speed 3], [»» Speed 2], [> Speed 1]	●	●	46
[AF Mode]	[LAF Instant AF], [AF Normal AF]	●	●	–
[AF-Assist Lamp]	[A Automatic], [OFF Off]	–	●	112
[Focus Priority]	[AiAF AiAF Frames], [□ Center Frame], [OFF Off]	–	●	–
[Focus Assistance]	[ON On], [OFF Off]	●	●	–
[Face Detection & Tracking]	[ON On  , [OFF Off]	●	●	67
[Auto Backlight Correction]	[ON On], [OFF Off]	●	●	75
[Auto Slow Shutter]	[ON On], [OFF Off]	●	–	–
[Image Effects]	[OFF Off], [A_v Vivid], [A_N Neutral], [A_S Low Sharpening], [A_D Soft Skin Detail], [A_C Custom Effect]	●	●	81
[Wind Screen]	[A Automatic], [OFF Off 	●	–	–
[Microphone Attenuator]	[A Automatic], [ON On ATT]	●	–	–
[Surround Mic Directionality]*	[5.1ch Surround], [5.1ch Zoom Zoom], [5.1ch Shotgun Shotgun]	●	–	–
[Surround Mic Attenuator]*	[ON On ATT], [OFF Off]	●	–	–
[Onscreen Markers]	[OFF Off], [EW Level (White)], [EG Level (Gray)], [EW Grid (White)], [EG Grid (Gray)]	●	●	–

Menu item	Setting options			
[Custom Key/Dial]	[OFF Off], [Focus], [Exposure], [Tv / Av], [Mic. Level], [AGC AGC Limit]	●	–	89
	[OFF Off], [Focus], [Exposure], [Tv / Av]	–	●	
[POWERED IS Button]	[ON Press and Hold], [TOFF Toggle On/Off]	●	–	65

* Option available only when the optional SM-V1 Surround Microphone is attached to the camcorder after having updated the camcorder's firmware using the memory card supplied with the SM-V1.

[Digital Zoom]: Determines the operation of the digital zoom. The color of the indicator indicates the zoom.

- When activated, the camcorder will switch automatically to digital zoom when you zoom in beyond the optical zoom range.
- With the digital zoom the image is digitally processed, so the image resolution will deteriorate the more you zoom in.

Optical zoom	Digital zoom	
White	Light blue	Dark blue
Up to 10x	10x - 40x	40x - 200x

[AF Mode]: Select how fast the autofocus will operate.

- With [**LAF** Instant AF] the autofocus adjusts quickly to a new subject. This is convenient for example when changing the focus from a near subject to a far subject in the background, or when recording moving subjects.
- When the optional Wide-converter or Tele-converter is attached to the camcorder, it may partially obstruct the Instant AF sensor. Set the AF mode to [**AF** Normal AF].

[Focus Priority]: When the focus priority is activated, the camcorder records a photo only after the focus has been adjusted automatically. You can also select which AF frames to use.

[**AiAF** AiAF Frames]: One or more AF frames out of the nine frames available are automatically selected and the focus is fixed on them.

[**Center Frame**]: A single focusing frame appears in the center of the screen and the focus is automatically fixed on it.

[OFF Off]: No AF frame will appear and the photo will be recorded immediately after you press **[PHOTO]**.

- When the recording program is set to [Fireworks], focus priority is automatically set to **[OFF Off]**.
- When focus priority is activated, if face detection (67) is also activated, the camcorder will focus on the face of the main subject (white face-detection frame) when one is detected.

[Focus Assistance]: When focus assistance is activated, the image at the center of the screen is magnified to help you focus manually (76).

- Using focus assistance will not affect the recordings. It will be cancelled automatically after 4 seconds or when you start recording.

[Auto Slow Shutter]: The camcorder automatically uses slow shutter speeds to obtain brighter recordings in places with insufficient lighting.

- Minimum shutter speed used: 1/30; 1/12 when the frame rate is set to **[PF24 PF24]** or **[24F 24F]**; 1/15 when it is set to **[PF30 PF30]**.
- The auto slow shutter can only be activated when the recording program is set to **[P Programmed AE]**, but the setting will not change even if you set the camcorder to mode.
- If a trailing afterimage appears, set the slow shutter to **[OFF Off]**.
- If (camcorder shake warning) appears, we recommend stabilizing the camcorder, for example, by mounting it on a tripod.

[Wind Screen]: The camcorder automatically reduces the background sound of wind when recording outdoors.

- Some low-frequency sounds will be suppressed along with the sound of wind. When recording in surroundings unaffected by wind or if you want to record low-frequency sounds, we recommend setting the wind screen to **[OFF Off]**

[Microphone Attenuator]: Helps prevent audio distortions.

[A Automatic]: The camcorder will automatically activate the microphone attenuator as necessary for optimal audio recording levels so high audio levels will not be distorted.

[ON On ATT]: The microphone attenuator will be activated at all times to reproduce more faithfully the sound dynamics. **ATT** will appear on the screen.

- This menu option is not available when the optional SM-V1 Surround Microphone is attached to the camcorder. In that case, activate the microphone attenuator with the [Surround Mic Attenuator] setting.

[Surround Mic Directionality]: Sets the directionality mode of the optional SM-V1 Surround Microphone.

[**5.1ch** Surround]: Records 5.1ch surround sound.

[**5.1ch** Zoom]: Records 5.1 audio channels. Additionally, the audio is linked to the zoom position. The larger the subject appears on the screen, the louder the sound will be as well.

[**5.1ch** Shotgun]: Records monaural audio with a highly directional setting that is most sensitive to sound coming directly from the front of the camcorder/microphone.

[Surround Mic Attenuator]: Helps prevent audio distortions due to high audio recording levels when the optional SM-V1 Surround Microphone is attached to the camcorder. When set to [**ON** On **ATT**], **ATT** will appear on the screen.

[Onscreen Markers]: You can display a grid or a horizontal line at the center of the screen. Use the markers as a reference to make sure your subject is framed correctly (vertically and/or horizontally).



















- Using the onscreen markers will not affect the recordings.





























[POWERED IS Button]: Determines the operation mode of the POWERED IS button.

[**ON** Press and Hold]: Powered IS will be activated while you hold the button pressed down.

[**ON/OFF** Toggle On/Off]: Each press of the button will turn the Powered IS function on and off.

Recording & Connections Setup

Menu item	Setting options					
[Self Timer]	[ON On  , [OFF Off]	●	●	–	–	83
[Video Snapshot Length]	[2sec 2 sec], [4sec 4 sec], [8sec 8 sec]	●	–	●	–	69, 100
[Rec Media for Movies]	 * (built-in memory),  ** (memory card A),  (memory card B) * Default for the HFS21/S20 . ** Default for the HFS200 . HFS21/S20 [Relay Recording]: [OFF] (Off),  A], [ A B],  B) HFS200 [Relay Recording]: [OFF] (Off),  B)	●	–	–	–	38
[Recording Mode]	[MPX High Quality 24 Mbps], [FXP High Quality 17 Mbps], [XP+ High Quality 12 Mbps], [SP Standard Play 7 Mbps], [LP Long Play 5 Mbps]	●	–	–	–	60
[Frame Rate]	[60i 60i (Standard)], [PF24 PF24], [PF30 PF30], [24F 24F]	●	–	–	–	–
[Rec Media for Photos]	 * (built-in memory),  ** (memory card A),  (memory card B) * Default for the HFS21/S20 . ** Default for the HFS200 .	●	●	●	–	38
[Simultaneous Recording]	[OFF Off], [LW 3264x1840], [MW 1920x1080] [ Super Fine], [ Fine], [ Normal]	●	–	–	–	114

Menu item	Setting options					
[Photo Quality/Size]	[LW 3264x1840], [L 3264x2456], [M 1920x1440], [S 640x480] [ Super Fine], [ Fine], [ Normal]	–	●	–	–	109
[Photo Capture from Video]	[ Single Photo], [ Photo Sequence]	–	–	●	–	101
[Photo Capture Quality]	[ Super Fine / 1920x1080], [ Fine / 1920x1080], [ Normal / 1920x1080]	–	–	●	–	101
[Memory Info]	[] (built-in memory), [ A] (memory card A), [ B] (memory card B)	●	●	●	●	–
[x.v.Color]	[ON On color], [OFF Off]	●	–	–	–	–
[Color Bars & Test Tone]	[OFF Off], [ Color Bars], [ Color Bars & Tone]	●	–	–	–	–
[Auto Rotate]	[ON On], [OFF Off]	–	●	–	–	–
[Photo Review Time]	[OFF Off], [ 2 sec], [ 4 sec], [ 6 sec], [ 8 sec], [ 10 sec]	–	●	–	–	–
[Photo Numbering]	[ Reset], [ Continuous]	●	●	●	●	–
[USB Connection Type]	[ DVD Burner], [ Computer/Printer], [ Connect and Set]	–	–	●	●	–
[Add Recordings to Disc]	[<u>All Scenes</u>], [<u>Remaining Scenes</u>]	–	–	●	–	136
[Paper Settings]	[Default], [9 x 13 cm], [13 x 18 cm], [10 x 14.8 cm], [Credit Card], [4 x 6 in.], [8.5 x 11 in.], [A3], [A4], [4 x 7.1 in.]	–	–	–	●	122

[Frame Rate]: Selects the frame rate to be used when recording.

[PF30 PF30]: 30 frames per second, progressive. Use this frame rate to easily edit your recordings, for example, to post them on the Web.

[PF24 PF24]: 24 frames per second, progressive. Using this frame rate will give your recordings a cinematic look. When combined with the **[Cine Mode]** recording program (63), the cinematic look will be enhanced. Using this frame rate, video is recorded as 60i and movies can be converted to standard definition in the camcorder.

[24F 24F]: 24 frames per second, progressive. Using this frame rate will achieve the same cinematic look as **[PF24 PF24]**, the difference being that video is recorded as true 24p. Use the supplied software **ImageMixer 3 SE** to convert movies recorded with this frame rate to standard definition.

[Memory Info]: Displays a screen where you can verify how much of the built-in memory (**[HFS21/S20]** only) or the memory card is currently in use (total recording time and total number of photos) and how much space remains available for recording.

- Estimated figures about available movie recording time and available number of photos are approximate and based on the recording mode and photo quality/size settings currently in use.
- In the information screen of a memory card you can also check its Speed Class.
- **[HFS21/S20]** The [Total space] shown for the built-in memory indicates actually usable space. It may be slightly smaller than the nominal built-in memory capacity listed in the Specifications.

[x.v.Color]: Uses a color space with an extended gamut to achieve deeper colors, closer to real life.

- Use this function to record video only when you intend to play back your recordings on an HDTV compatible with x.v.Color, connected to the camcorder using an HDMI cable. If recordings made with x.v.Color are played back on a non-compatible TV, colors may not be reproduced correctly.

[Color Bars & Test Tone]: Use the color bars to calibrate the colors on an external TV or monitor.

[Color Bars]: Displays a standard SMPTE color bar pattern.

[Color Bars & Tone]: In addition to the color bar pattern, a 1 kHz, -12 dB test tone is output.

- Connect the camcorder to the TV or monitor and display the color bars (if desired, along with the test tone). Check the colors and audio recording levels on the external monitor and adjust as necessary.

[Auto Rotate]: Photos that were recorded in portrait orientation (by turning the camcorder on its side), will be rotated automatically and displayed correctly during playback.

[Photo Review Time]: Selects the time to display a photo after it has been recorded.

- The review time can only be set when the drive mode is set to Single].

[Photo Numbering]: Select the photo numbering method to be used on a new memory card. Photos are automatically assigned consecutive numbers from 0101 to 9900, and stored in folders containing up to 100 photos. Folders are numbered from 101 to 998.

 Reset]: Photo numbers will restart from 101-0101 every time you insert a new memory card.

 Continuous]: Photo numbers will continue from the number following that of the last photo recorded with the camcorder.











- If the memory card you insert already contains a photo with a larger number, a new photo will be assigned a number one higher than that of the last photo on the memory card.
- We recommend using the  Continuous] setting.
- The photo number indicates the name and location of the file on the memory card. For example, the file name of a photo numbered 101-0107 is “IMG_0107.JPG”, stored under the folder “DCIM\101\CANON”.

[USB Connection Type]: Select the connection protocol to use when connecting the camcorder to an external device using the supplied USB cable.

 DVD Burner]: To connect exclusively to the optional DW-100 DVD Burner.

 Computer/Printer]: To connect to a computer, printer or similar USB peripheral.

 Connect and Set]: To make the selection from a screen that appears at the time of the connection to the external device.

Menu item	Setting options			
[Select Music]	[OFF Off] , [ON On] When [ON On] - list of music tracks	● ¹	●	93
[External Audio Input]	[OFF Off] , [ON On]   When [ON On] - [External Player Link]: Toggle on (●) or off (○)	●	●	95
[Data Code]	 Date],  Time],  Date and Time],  Camera Data]	●	-	-
[Slideshow Transition]	[OFF Off] ,  Dissolve],  Slide Image]	-	●	116
[TV Type] ²	[4:3 Normal TV] , [16:9 Wide TV]	●	-	-

¹ Option available only from the [Playlist] or [Video Snapshot] → [Original]/[Playlist] index screen.

² Option not available when the camcorder is connected to an HDTV using an HDMI cable.

[Data Code]: Displays the date and/or time when the scene was recorded.

 Camera Data]: Displays the aperture (f-stop) and shutter speed used when recording the scene.

















[TV Type]: When you connect the camcorder to a TV using the supplied STV-250N Stereo Video Cable, select the setting according to the type of TV in order to display the picture in full and in the correct aspect ratio.

[4:3 Normal TV]: TV sets with 4:3 aspect ratio.

[16:9 Wide TV]: TV sets with 16:9 aspect ratio.

- When the TV type is set to **[4:3 Normal TV]**, during the playback of video originally recorded with an aspect ratio of 16:9, the picture will not be displayed fullscreen.

System Setup

Menu item	Setting options					
[Font Size]	[ Large], [ Small]	●	●	●	●	–
[Output Onscreen Displays]	[ON On], [OFF Off]	●	●	●	●	–
[Language ]	[Česky], [Deutsch], [Ελληνικά], [English], [Español], [Français], [Italiano], [Magyar], [Melayu], [Nederlands], [Polski], [Português], [Română], [Türkçe], [Русский], [Українська], [العربية], [فارسی], [ภาษาไทย], [简体中文], [繁體中文], [한국어], [日本語]	●	●	●	●	35
[LCD Brightness]		●	●	●	●	–
[LCD Screen Dimmer]	[ON On], [OFF Off]	●	●	●	●	–
[AV/Headphones]	[AV AV], [ Headphones]	●	–	●	●	85
[Volume]	Speaker:  , 	–	–	●	●	51, 85
	Headphone:  , 	●	–	●	●	
[Notification Sounds]	[ High Volume], [ Low Volume], [OFF Off]	●	●	●	●	–
[Wireless Remote Control]	[ON On], [OFF Off ]	●	●	●	●	–
[Power Saving Mode]	[Auto Power Off]: [ON On], [OFF Off] [Quick Start (Standby)]: [OFF Off], [10min 10 min], [20min 20 min], [30min 30 min]	●	●	●	●	–

Menu item	Setting options					
HFS21/S20 [Initialize /	[Built-in Mem.], [A Mem. Card A], [B Mem. Card B] [Complete Initialization]: Toggle on (●) or off (○)	●	●	● ¹	●	40
HFS200 [Initialize	[A Mem. Card A], [B Mem. Card B] [Complete Initialization]: Toggle on (●) or off (○)					
[Time Zone/DST]	[] (home time zone) or [] (travel time zone): [<u>New York</u>], list of world time zones [] (DST adjustment)	●	●	●	●	35
[Date/Time]	[Date/Time]: – [Date Format]: [Y.M.D], [<u>M.D.Y</u>], [D.M.Y] (Y- year, M- month, D- day) [24H]: Toggle On (●, 24-hour clock) or Off (○, 12-hour clock)	●	●	●	●	34
[Calendar Start Day]	[Saturday], [Sunday], [<u>Monday</u>]	–	–	●	–	–
[Battery Info]	–	●	●	●	●	–
[Control for HDMI] ²	[ON On], [OFF Off]	●	●	●	●	–
[HDMI Status]	–	●	●	●	●	–
[Distance Units]	[m meters], [ft feet]	●	●	–	–	–
[Demo Mode]	[ON On], [OFF Off]	●	●	–	–	–
[Reset All]	[No], [Yes]	●	●	●	●	–
[Firmware]	–	–	–	–	●	–
[Eye-Fi Communication] ³	[A Automatic], [OFF Off]	●	●	●	●	150

¹ Option not available from the [Playlist] index screen.

² Option not available when the camcorder is connected to an HDTV using an HDMI cable.

³ Option available only after having inserted an Eye-Fi card in memory card slot **B**.

[Font Size]: Changes the size of the font for the menu and other screens.

- When the font size is set to [**A** Large], some information may be displayed in shortened form (icons only, etc.). Some screens will be displayed using the small font size regardless of the setting.

[Output Onscreen Displays]

- When set to [**ON** On], the camcorder's onscreen displays will appear also on the screen of a TV or monitor connected to the camcorder.

[LCD Brightness]: Adjusts the brightness of the LCD screen.

- Changing the brightness of the LCD screen does not affect the brightness of your recordings, the brightness of the viewfinder (**HFS21** only) or the brightness of the playback image on a TV.

[LCD Screen Dimmer]: When set to [**ON** On], the LCD screen is dimmed. Doing so is ideal when using the camcorder in locations where the LCD's illumination could become a nuisance to others. Hold [**DISP.**] pressed down for about 2 seconds to restore the LCD screen to its previous brightness setting.

- Dimming the LCD screen does not affect the brightness of your recordings or the brightness of the playback image on a TV.
- When the screen dimmer is set to [**OFF** Off], the LCD screen will return to the brightness level that was in use before the screen was dimmed.

[Notification Sounds]: A beep will accompany some operations like turning on the camcorder, the self-timer countdown, etc.

[Wireless Remote Control]: Allows the camcorder to be operated with the wireless controller.

[Power Saving Mode]: Controls the camcorder's automatic power off settings.





[Auto Power Off]: In order to save power when the camcorder is powered by a battery pack, it will automatically shut off if left without any operation for 5 minutes.

- Approximately 30 seconds before the camcorder shuts off, [Auto power off] will appear.
- In standby mode, the camcorder will shut off after the time selected for the [Quick Start (Standby)] setting.



[Quick Start (Standby)]: Select whether to activate the Quick Start function (**47**) when you close the LCD panel in a recording mode and the length of time after which the camcorder will end the standby mode and shut off automatically.

- You can set Quick Start to [**OFF** Off], for example, if the camcorder is set on a fixed position and you want to keep recording video with the LCD panel closed in order to conserve the battery's power.

[Calendar Start Day]: Select the day on which the week in the calendar screen ( 56).

[Battery Info]: Displays a screen where you can verify the battery charge (as a percentage) and the remaining recording time (,  mode) or playback time (,  mode).

[Control for HDMI]: Activates the HDMI-CEC (Consumer Electronics Control) function. When you connect the camcorder to an HDTV compatible with HDMI-CEC using an HDMI cable, you can control the camcorder's playback using the remote control of the TV.

- If set to [**ON** On], when the camcorder is connected to a compatible HDTV using an HDMI cable, the video input on the TV will automatically be set to the camcorder's video input. Then, you can use the up/down/left/right buttons and the OK or SET button on the TV's remote control to play back your recordings.
- Depending on the TV set, additional settings may be required on the TV itself to activate the HDMI-CEC function. Refer to the TV's instruction manual.
- Correct operation of the HDMI-CEC function cannot be guaranteed even when connecting the camcorder to compatible TV sets. If you cannot use the remote control of the TV, set [Control for HDMI] to [**OFF** Off] and operate the camcorder directly or use the camcorder's wireless controller.
- The remote control of the TV can only be used to play back movies or photos ( or  mode only). If the camcorder is connected to the TV while it is set to a recording mode, depending on the TV used, turning off the TV will automatically turn off the camcorder even if it is recording at the time.
- We recommend not connecting more than 3 HDMI-CEC compatible devices at a time.

[HDMI Status]: Displays a screen where you can verify the standard of the output signal from the HDMI OUT terminal.

[Distance Units]: Selects the units to use for the focusing distance display during manual focus.

[Demo Mode]: The demonstration mode displays the camcorder's main features. It starts automatically when the camcorder is powered with the compact power adapter if you leave it turned on without a memory card for more than 5 minutes.

- To cancel the demo mode once it has started, press any button or turn off the camcorder.

[Reset All]: Resets all the camcorder's settings to default values.

[Firmware]: You can verify the current version of the camcorder's firmware. This menu option is usually unavailable.

Appendix: Onscreen Icons and Displays

Recording Movies (in Dual Shot mode)

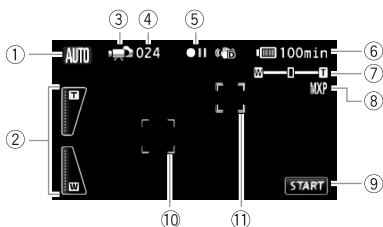

- | | |
|---|--|
| ① Smart AUTO mode (📖 43) | ⑦ Zoom (📖 46) |
| ② Onscreen zoom controls (📖 46) | ⑧ Recording mode (📖 60) |
| ③ Operating mode (📖 30) | ⑨ Control button: Start/Stop video recording |
| ④ In record pause mode:
Total number of scenes | ⑩ Face detection frame (📖 67) |
| ⑤ Memory operation (📖 174) | ⑪ Touch & Track frame (📖 68) |
| ⑥ Remaining battery time (📖 174) | |

Recording Movies (in M Manual mode)

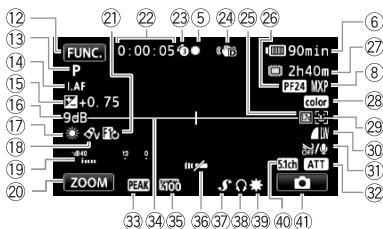

- 12 Control button: Open the FUNC. panel (32)
- 13 Recording program (61, 63, 71)
- 14 **I.Af** Instant AF (157), MF Manual focus (76)
- 15 Manual exposure (74)
- 16 AGC (automatic gain) limit (76)
- 17 White balance (79)
- 18 Image effect (81)
- 19 Audio level indicator (83)
- 20 Control button: Last function used ([ZOOM] in this case)
- 21 Digital effect (70)
- 22 While recording/during playback: Scene counter (hours : minutes : seconds)
- 23 Pre-recording (66)
- 24 Image stabilizer (64)
- 25 Digital tele-converter (80)
- 26 PF24 progressive frame rate (63, 174)
- 27 Remaining recording time
A, B On memory card **A** or **B**
C In the built-in memory*
D*, E Relay recording (39)
 * **HFS21/S20** only.
- 28 x.v.Color (162)
- 29 Face detection (67)
- 30 Photo quality/size (simultaneous recording) (114)
- 31 Wind screen off (158)
- 32 Microphone attenuator (158), Surround microphone attenuator (159)
- 33 Peaking (78)
- 34 Level marker (159)
- 35 Zebra pattern (75)
- 36 Remote sensor off (167)
- 37 Mini advanced shoe (86)
- 38 Headphone output (85)
- 39 Mini video light (82)
- 40 Microphone directionality of the SM-V1 (87)
- 41 Control button: Switch to photo recording (108)

Recording Photos (in M Manual mode)

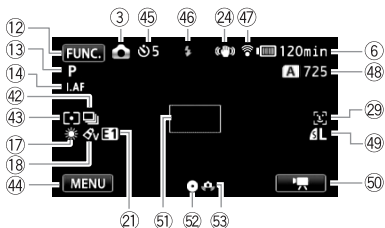

- ④② Drive mode (📖 113)
- ④③ Light metering mode (📖 115)
- ④④ Control button: Last function used ([MENU] in this case)
- ④⑤ Self timer (📖 83)
- ④⑥ Flash (📖 111)
- ④⑦ Eye-Fi wireless communication (📖 150)
- ④⑧ Number of available photos
A, B On memory card A or B
HFS21/S20  In the built-in memory
- ④⑨ Photo quality/size (📖 109)
- ④⑩ Control button: Switch to movie recording (📖 59)
- ④⑪ AF frame (📖 157)
- ④⑫ Focus and exposure lock (📖 42, 108)
- ④⑬ Camcorder shake warning (📖 158)

Playing Movies (during playback)



- ⑤④ Playback control buttons (📖 49)
- ⑤⑤ External audio input (📖 95)
- ⑤⑥ Scene number
- ⑤⑦ Data code (📖 97, 164)
- ⑤⑧ Volume (📖 49)

Viewing Photos

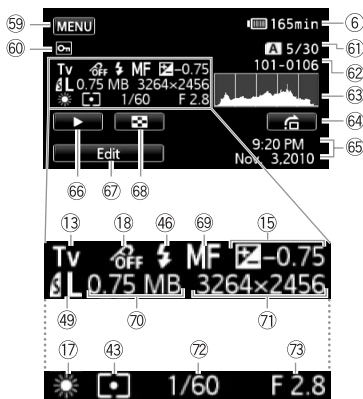

Exif information panel

- 59 Control button: Open the setup menus (156)
- 60 Protected photo mark (118)
- 61 Current photo / Total number of photos
- 62 Photo number (163)
- 63 Histogram (118)
- 64 Control button: Photo jump (105)
- 65 Date and time of recording
- 66 Control button: Slideshow (116)
- 67 Control button: Open the Edit panel (155)
- 68 Control button: Switch to [Photos] index screen (104)
- 69 Manual focus (76)
- 70 File size
- 71 Photo size (109)
- 72 Shutter speed (71)
- 73 Aperture value (71)



⑤ Memory operation

- Record, ●|| Record pause, ▶ Playback, || Playback pause, ▶▶ Fast playback, ◀◀ Fast reverse playback, |▶ Slow playback, ◀| Slow reverse playback, ||▶ Frame advance, ◀|| Frame reverse.

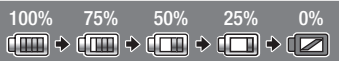

⑥ Remaining battery time

- The icon shows a rough estimate of the remaining charge as a percentage of the full charge of the battery pack. The remaining recording/playback time of the battery pack is displayed, in minutes, next to the icon.



- When  is displayed in red, replace the battery pack with a fully charged one.
- When you attach an empty battery pack, the power may turn off without displaying .
- Depending on the conditions under which the camcorder and the battery pack are used, the actual battery charge may not be indicated accurately.
- When the camcorder is off, press **[BATT.INFO]** to display the charge status of a battery pack. The Intelligent System will display the charge status (as a percentage) and the remaining recording time (in minutes) for 5 seconds. If the battery pack is exhausted, the battery information may not be displayed.

⑥ PF24 progressive frame rate

Select the PF24 or 24F progressive frame rate ( 63) to give your recordings a cinematic look. You can combine this frame rate with the [ Cine Mode] recording program to enhance the effect.

⑦ Remaining recording time

When there is no more free space on the memory, [ End] (built-in memory, **[HFS21/S20]** only) or [**[A]** End] (memory card **[A]**) or [**[B]** End] (memory card **[B]**) will be displayed in red and the recording will stop.

⑧ Number of available photos

 /  in red: There is no memory card in the corresponding memory card slot.
[A] / **[B]** in green: 6 or more photos ➔ in yellow: 1 to 5 photos ➔ in red: No more photos can be recorded.

- When viewing the photos, the display will always be in green.
- Depending on the recording conditions, the number of available photos displayed may not decrease even after a recording has been made, or may decrease by 2 photos at once.

Troubleshooting

If you have a problem with your camcorder, refer to this section. Sometimes what you think is a malfunction of the camcorder may have the simplest of solutions - please read the “CHECK THIS FIRST” box before going on to the more detailed problems and solutions. Consult your dealer or a Canon Service Center if the problem persists.

CHECK THIS FIRST

Power supply

- Is the battery charged? Is the compact power adapter correctly connected to the camcorder? (📖 22)

Recording

- Did you turn the camcorder on and correctly set it to a recording mode? (📖 42, 59, 108) If you are recording on a memory card, is one correctly inserted into the camcorder? (📖 37)

Playback

- Did you turn the camcorder on and correctly set it to playback mode? (📖 49, 104) If you are playing back recordings from a memory card, is one correctly inserted into the camcorder? (📖 37) Does it contain any recordings?

Other

- Does the camcorder make a rattling sound? The internal lens fixture can move when the camcorder is turned off or in a playback mode. This is not a malfunction.

Power source

The camcorder will not turn on or it turns off by itself.

- The battery pack is exhausted. Replace or charge the battery pack.
- Remove the battery pack and reattach it correctly.

Cannot charge the battery pack.

- Make sure the camcorder is off so charging can start.
- The temperature of the battery pack is outside the charging range. If the battery pack's temperature is below 0 °C (32 °F), warm it before charging it; if it is above 40 °C (104 °F), let the battery pack cool down before charging it.
- Charge the battery pack in temperatures between 0 °C and 40 °C (32 °F and 104 °F).
- The battery pack is faulty. Replace the battery pack.
- The camcorder cannot communicate with the battery pack attached. Such battery packs cannot be charged using this camcorder.

A noise can be heard from the compact power adapter.



- A faint sound can be heard while the compact power adapter is connected to a power outlet. This is not a malfunction.

The battery pack is exhausted extremely quickly even at normal temperatures.

- The battery may have reached the end of its battery life. Buy a new battery pack.

Recording



Pressing  will not start recording.

- You cannot record while the camcorder is writing previous recordings onto the memory (while the ACCESS indicator is on or flashing). Wait until the camcorder has finished.
- The memory is full or it already contains the maximum number of scenes (3,999 scenes). Delete some recordings ( 57, 106) or initialize the memory ( 40) to free some space.

The point where  was pressed does not match the beginning/end of the recording.



- There is a slight interval between pressing  and the actual start/end of recording. This is not a malfunction.



The camcorder will not focus.

- Autofocus does not work on the subject. Focus manually ( 76).
- The lens or Instant AF sensor is dirty. Clean the lens or sensor with a soft lens-cleaning cloth ( 199). Never use tissue paper to clean the lens.



When a subject flits across in front of the lens, the image appears slightly bent.

- This is a phenomenon typical of CMOS image sensors. When a subject crosses very quickly in front of the camcorder, the image may seem slightly warped. This is not a malfunction.







Changing the operating mode between recording ()/record pause ()/playback () takes longer than usual.

- When the memory contains a large number of scenes, some operations may take longer than usual. Save your recordings ( 133) and initialize the memory ( 40).

Movies or photos cannot be recorded properly.

- This may occur as movies and photos are recorded/deleted over time. Save your recordings ( 133) and initialize the memory ( 40).

Cannot record a photo in  mode.

- You cannot take photos in this mode if   [Simultaneous Recording] is set to [Off] ( 114), or if either the digital zoom ( 157) or a digital effect ( 70) is activated. Also, photos cannot be recorded at [LW 3264x1840] size while the digital tele-converter ( 80) is activated.

After using the camcorder for a long time, it becomes hot.

- The camcorder may become hot after using it continuously for long periods of time; this is not a malfunction. If the camcorder becomes unusually hot or it becomes hot after using it only for a short while, it may indicate a problem with the camcorder. Consult a Canon Service Center.

Playback

Cannot add scenes to the playlist.

- The playlist can contain a maximum of 999 scenes. If the playlist includes scenes recorded in MXP or FXP mode, the maximum number of scenes in the playlist may be less than 999.
- You may not be able to add to the playlist scenes recorded or edited using another device.
- The memory is full. Delete some recordings (📖 57, 106) or initialize the memory (📖 40) to free some space.

Cannot move scenes in the playlist.

- The memory is full. Delete some recordings (📖 57, 106) or initialize the memory (📖 40) to free some space.

Cannot delete a scene.

- You may not be able to delete scenes recorded or edited using another device.

Deleting scenes takes longer than usual.

- When the memory contains a large number of scenes, some operations may take longer than usual. Save your recordings (📖 133) and initialize the memory (📖 40).

Cannot delete a photo.

- The photo is protected. Remove the protection (📖 118).

Cannot capture a video snapshot scene from a movie.

- You cannot capture video snapshot scenes from scenes recorded or edited using another device.
- The memory is full. Delete some recordings (📖 57, 106) or initialize the memory (📖 40) to free some space.



When playing back scenes/slideshow with background music, the music track is not played back correctly.

- This can occur when you transfer the music files to a memory after repeatedly recording and deleting scenes (fragmented memory). Save your recordings (📖 133) and initialize the memory (📖 40). Then, transfer the music files first and only then write the video files back to the memory.
- Music tracks will not play back correctly if the connection was interrupted while transferring the music files. Delete the music tracks and transfer the music files again.
- The transfer rate of the memory card used is too slow. Use a recommended memory card (📖 36).

When playing scenes/a slideshow linked to external audio, the video playback is not correctly linked to the external player.

- The volume of external player may be too low. Try increasing the volume of the external player.

Cannot divide scenes

- You cannot divide scenes recorded or edited using another device.
- The memory is full. Delete some recordings ( 57, 106) or initialize the memory ( 40) to free some space.

Cannot copy scenes/photos

- You may not be able to copy scenes/photos recorded or edited using another device.

Cannot mark individual scenes/photos in the index screen with a checkmark ✓

- You cannot select more than 100 scenes/photos individually. Reduce the number of selected scenes/photos or use the [Select All] option.

Indicators and Onscreen Displays

 lights up in red.

- Battery pack is exhausted. Replace or charge the battery pack.

 appears on the screen.

- The camcorder cannot communicate with the battery pack attached so the remaining battery time cannot be displayed.

 /  lights up in red.

- A memory card error occurred. Turn off the camcorder. Remove and reinsert the memory card. Initialize the memory card if the display does not change back to normal.
- The memory card is full. Replace the memory card or delete some recordings ( 57, 106) to free some space on the memory card.

 flashes in red on the screen.

- The camcorder has malfunctioned. Consult a Canon Service Center.

Even after stopping recording, the ACCESS indicator does not go off.

- The scene is being recorded in the memory. This is not a malfunction.

The red ON/OFF (CHG) indicator flashes rapidly ( one flash at 0.5-second intervals).

- Charging has stopped because the compact power adapter or the battery pack is faulty. Consult a Canon Service Center.

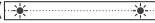
The red ON/OFF (CHG) indicator flashes very slowly () one flash at 2-second intervals).

- The temperature of the battery pack is outside the charging range. If the battery pack's temperature is below 0 °C (32 °F), warm it before charging it; if it is above 40 °C (104 °F), let the battery pack cool down before charging it.
- Charge the battery pack in temperatures between 0 °C and 40 °C (32 °F and 104 °F).
- The battery pack is damaged. Use a different battery pack.

 appears on the screen

- The LOCK switch on the Eye-Fi card is set to prevent accidental erasure. Change the position of the LOCK switch.
- An error occurred when trying to access control data on the Eye-Fi card. Turn the camcorder off then on again. If the icon appears often, there might be a problem with the Eye-Fi card. Contact the card manufacturer's customer care.

Picture and Sound



The screen appears too dark.

- The LCD screen was dimmed. Hold  pressed down for 2 seconds to restore the LCD screen to its previous brightness setting.

Screen displays turn on and off repeatedly.

- The battery pack is exhausted. Replace or charge the battery pack.
- Remove the battery pack and reattach it correctly.

Abnormal characters appear on the screen and the camcorder does not operate properly.

- Disconnect the power source and reconnect it after a short time. If the problem still persists, use the   [Reset All] menu option to reset all the camcorder's settings to default values.

Video noise appears on screen.

- Keep a distance between the camcorder and devices that emit strong electromagnetic fields (plasma TVs, cellular phones, etc.).

Horizontal bands appear on the screen.

- This is a phenomenon typical of CMOS image sensors when recording under some types of fluorescent, mercury or sodium lamps. To reduce the symptoms, set the recording program to [Programmed AE] or [Shutter-Pri. AE] ( 71). This is not a malfunction.

HFS21 No picture appears on the viewfinder.

- Pull out the viewfinder until it clicks to activate the viewfinder ( 28).

HFS21 Viewfinder picture is blurred.

- Adjust the viewfinder with the dioptic adjustment lever ( 28).



Noise can be heard along with the recorded sound

- When recording sound with an external microphone, the interference caused by wireless communications may be picked up and recorded as noise. We recommend turning off the wireless communication while recording (📖 151).

Sound is distorted or is recorded at lower levels.

- When recording near loud sounds (such as fireworks, shows or concerts), sound may become distorted or it may not be recorded at the actual levels. Activate the microphone attenuator (📖 158) or adjust the audio recording level manually (📖 83).

The picture is displayed correctly but there is no sound from the built-in speaker.



- Speaker volume is turned off. Adjust the volume.
- If the STV-250N Stereo Video Cable is connected to the camcorder, disconnect it.
- The AV terminal is set to headphone output. Set   [AV/Headphones] to [AV].

Memory Card and Accessories



Cannot insert the memory card.

- The memory card was not facing the correct direction. Turn the memory card over and insert it.



Cannot record on the memory card.

- The memory card is full. Delete some recordings (📖 57, 106) to free some space or replace the memory card.
- Initialize the memory card (📖 40) when you use it with the camcorder for the first time.
- The LOCK switch on the memory card is set to prevent accidental erasure. Change the position of the LOCK switch.
- A compatible memory card must be used to be able to record movies on a memory card (📖 36).
- The folder and file numbers have reached their maximum value. Set   [Photo Numbering] to [Reset] and insert a new memory card.

The wireless controller will not work.

- Set   [Wireless Remote Control] to [On].
- Replace the battery of the wireless controller.

Cannot upload files wirelessly using an Eye-Fi card.

- You may have inserted the Eye-Fi card into memory card slot **A**. Insert it into memory card slot **B**.
-  [Eye-Fi Communication] is set to [Off] ( appears onscreen). Set it to [Automatic].
- Opening the LCD panel may help when the wireless connection is not strong enough.
- If certain conditions occur while uploading files, such as the camcorder becoming too hot or the wireless connection getting too weak, the camcorder may stop the wireless upload ( appears onscreen). Turn off the camcorder and let it cool down or move to a location with a stronger wireless signal.
- Contact the card manufacturer's customer care.

The wireless communication status icon does not appear

- You may have inserted the Eye-Fi card into memory card slot **A**. Insert it into memory card slot **B**.

Connections with External Devices

Video noise appears on the TV screen.

- When using the camcorder in a room where a TV is located, keep a distance between the compact power adapter and the power or antenna cables of the TV.

Playback looks fine on the camcorder but there is no image on the TV screen.

- The video input on the TV is not set to the video terminal to which you connected the camcorder. Select the correct video input.

There is no sound from the TV.

- When connecting the camcorder to an HDTV using the CTC-100/S Component Cable, make sure to connect also the audio connections using the white and red plugs of the STV-250N Stereo Video Cable.



The camcorder is connected using the optional HTC-100 HDMI Cable, but there is no picture or sound from the HDTV.

- Disconnect the HTC-100 HDMI Cable and then restore the connection or turn the camcorder off and then on again.



The camcorder is connected using the optional HTC-100 HDMI Cable, but HDMI-CEC does not work (cannot play back using the TV's remote control).

- Disconnect the HTC-100 HDMI cable and turn off the camcorder and the TV. After a short while turn them on again and restore the connection.
-  [Control for HDMI] is set to [Off]. Set it to [On].
- HDMI-CEC is not activated on the connected TV. Activate this function on the TV.
- Even with TV sets compatible with HDMI-CEC the range of functions available differs depending on the type of TV. Refer to the instruction manual of the connected TV.

The computer does not recognize the camcorder even though the camcorder is connected correctly.

-   [USB Connection Type] is set to [DVD Burner]. Set it to [Computer/Printer] or to [Connect and Set].
- Disconnect the USB cable and turn off the camcorder. After a short while, turn it on again and restore the connection.
- Connect the camcorder to a different USB port on the computer.
- The camcorder will not be correctly recognized if you connected the USB cable to the computer while the camcorder was deleting all the photos. Disconnect the USB cable and restore the connection once the operation is completed.

The printer is not working even though the camcorder and printer are connected correctly.

-   [USB Connection Type] is set to [DVD Burner]. Set it to [Computer/Printer] or to [Connect and Set].
- Disconnect the USB cable and turn off the printer. After a short while turn it on again and restore the connection.
- Cannot connect to a PictBridge-compatible printer if the memory contains 2,500 photos or more.

After connecting the camcorder to a printer, the message [Busy] continues to appear on the screen

- Disconnect the USB cable and restore the connection after a short while.



Photos are not correctly printed

- You may not be able to print correctly, using a PictBridge-compatible printer, photos whose file names have been changed or that were recorded, created, edited or changed using another device.

Cannot save photos on my computer

- When the memory contains too many photos (Windows – 2,500 photos or more, Macintosh – 1,000 photos or more), you may not be able to transfer photos to a computer. Try using a card reader to transfer the photos on the memory card. **HFS21/S20** only: To transfer the photos in the built-in memory, copy them to the memory card in advance ( 130).

The camcorder does not recognize the DW-100 DVD Burner even though it is connected correctly.

-   [USB Connection Type] is set to [Computer/Printer]. Set it to [DVD Burner] or to [Connect and Set].

List of Messages (in alphabetical order)

Following the list of messages for the camcorder you can find separate lists for print-related messages (📖 191) and for messages that appear only when using the optional DW-100 DVD Burner (📖 190).

Accessing the memory card. Do not remove the memory card.

- You opened the memory card slot cover while the camcorder was accessing the memory card or the camcorder started accessing the memory card as you opened the memory card slot cover. Do not remove the memory card until this message disappears.

AVCHD discs cannot include MXP scenes

- AVCHD discs created with the optional DW-100 DVD Burner cannot contain scenes recorded in MXP mode. Select only those scenes recorded in other recording modes to create the disc (📖 135).

Back up recordings regularly

- This message may appear when you turn on the camcorder. In the event of a malfunction, recordings may be lost so back up your recordings regularly.

Buffer overflow. Recording was stopped.

- The data transfer rate was too high for the memory card in use and the recording was stopped. Replace the memory card with one rated Speed Class 2, 4, 6 or 10.

HFS21/S20 Built-in memory error

- The built-in memory could not be read. Contact a Canon Service Center.

HFS21/S20 Built-in memory is full

- The built-in memory is full ([📺] End] appears on the screen). Delete some recordings (📖 57, 106) to free some space. Save your recordings (📖 133) and initialize the built-in memory (📖 40).



HFS21/S20 Cannot access the built-in memory

- There is a problem with the built-in memory. Contact a Canon Service Center.

Cannot communicate with the battery pack. Continue using this battery pack?

- You attached a battery pack that is not recommended by Canon for use with this camcorder.
- If you are using a battery pack recommended by Canon for use with this camcorder, there may be a problem with the camcorder or battery pack. Consult a Canon Service Center.

Cannot convert

- Cannot access the memory card. Check the memory card and make sure it is inserted correctly.
- You inserted a MultiMedia Card (MMC) into the camcorder. Use a recommended memory card (📖 36).
- There was an error creating the file name. Set   [Photo Numbering] to [Reset] and initialize the memory card or delete all the photos (📖 106) and all the scenes in the [For Web Upload] and [For DVD Burning] index screens (📖 57).

Cannot copy

- The total size of the scenes you selected to copy exceeds the available space on memory card **B**. Delete some recordings on the memory card (📖 57, 106) or reduce the number of scenes to copy.
- Memory card **B** already contains the maximum number of scenes (3,999 scenes). Delete some scenes (📖 57) to free some space.

Cannot divide the scene. Initialize only using the camcorder.

- The scene could not be divided because the camcorder's internal scene management data log is full. Save your recordings (📖 130) and initialize the memory (📖 40). Write back the backup files and try dividing the scene again.

Cannot edit

- Could not move a scene in the playlist. Delete some scenes from the playlist (📖 99).

Cannot enter standby mode now

- The camcorder cannot enter standby mode if the remaining battery charge is too low. Charge or replace the battery pack (📖 22).

Cannot play back

- There is a problem with the memory. If this message appears often without apparent reason, contact a Canon Service Center.

HFS21/S20 Cannot play back Cannot access the built-in memory

- There is a problem with the built-in memory. Save your recordings (📖 133) and initialize the built-in memory using the [Complete Initialization] option (📖 40). If the problem persists, contact a Canon Service Center.

Cannot play back Check the memory card

- There is a problem with the memory card. Save your recordings (📖 133) and initialize the memory card using the [Complete Initialization] option (📖 40). If the problem persists, use a different memory card.

HFS21/S20 Cannot play the movies in the built-in memory Initialize only using the camcorder

- The camcorder's built-in memory was initialized using a computer. Initialize the built-in memory with this camcorder (📖 40).

Cannot play the movies on this memory card

- Movies cannot be played back from a 64 MB or smaller memory card. Use a recommended memory card (📖 36).

Cannot play the movies on this memory card Initialize only using the camcorder

- The memory card in the camcorder was initialized using a computer. Initialize the memory card with this camcorder (📖 40).

Cannot record

- You cannot capture video snapshot scenes from scenes recorded or edited using another device.
- There is a problem with the memory. If this message appears often without apparent reason, contact a Canon Service Center.

HFS21/S20 Cannot record Cannot access the built-in memory

- There is a problem with the built-in memory. Save your recordings (📖 133) and initialize the built-in memory using the [Complete Initialization] option (📖 40). If the problem persists, contact a Canon Service Center.

Cannot record Check the memory card

- There is a problem with the memory card. Save your recordings (📖 133) and initialize the memory card using the [Complete Initialization] option (📖 40). If the problem persists, use a different memory card.

HFS21/S20 Cannot record movies in the built-in memory Initialize only using the camcorder

- The camcorder's built-in memory was initialized using a computer. Initialize the built-in memory with this camcorder (📖 40).

Cannot record movies on this memory card

- Movies cannot be recorded on a 64 MB or smaller memory card. Use a recommended memory card (📖 36).

Cannot record movies on this memory card Initialize only using the camcorder

- The memory card in the camcorder was initialized using a computer. Initialize the memory card with this camcorder (📖 40).

Change the battery pack

- Battery pack is exhausted. Replace or charge the battery pack.

Check the memory card

- Cannot access the memory card. Check the memory card and make sure it is inserted correctly.
- A memory card error occurred. The camcorder cannot record or display the image. Try removing and reinserting the memory card, or use a different memory card.
- You inserted a MultiMedia Card (MMC) into the camcorder. Use a recommended memory card (📄 36).
- If after the message disappears, [A] / [B] appears in red, perform the following: Turn off the camcorder and remove and reinsert the memory card. If [A] / [B] turns back to green you can resume recording/playback. If the problem persists, save your recordings (📄 133) and initialize the memory card (📄 40).

Could not add the scene(s) to the playlist

- One or more scenes could not be added to the playlist. The playlist can contain a maximum of 999 scenes. If the playlist includes scenes recorded in MXP or FXP mode, the maximum number of scenes in the playlist may be less than 999. Delete some scenes from the playlist (📄 99).

Do not disconnect the USB cable or the power source until you safely end the connection from the computer. Cannot write data with this connection. To write data to the camcorder, connect the compact power adapter then reconnect the camcorder and computer.

- The camcorder cannot be operated while it is not being powered by the compact power adapter and is connected to a computer with the supplied USB cable. In addition, scenes cannot be written back and music files cannot be transferred to the camcorder. To avoid corrupting the data in the camcorder's memory, use the computer's Safely Remove Hardware function to end the connection and disconnect the USB cable before using the camcorder.
- To be able to write back scenes and to transfer music files to the camcorder, use the computer's Safely Remove Hardware function to end the connection, disconnect the USB cable, power the camcorder using the compact power adapter and only then connect it to the computer again.



Do not disconnect the USB cable or the power source until you safely end the connection from the computer. Connect the compact power adapter

- When the camcorder is in  mode and is connected to the computer with the supplied USB cable, the camcorder cannot be operated. Disconnecting the USB cable or power source while this message appears may result in permanent loss of the recordings in the camcorder. Use the computer's Safely Remove Hardware function to end the connection and disconnect the USB cable before using the camcorder.
- To be able to write back scenes and to transfer music files to the camcorder, power the camcorder using the compact power adapter and only then connect it to the computer using the supplied USB cable.

Error writing on the memory card. Data may be recovered if the memory card has not been removed. Attempt recovering the data?

- This message will appear the next time you turn on the camcorder if power supply was accidentally interrupted while the camcorder was writing on the memory card. Select [Yes] to try to recover the recordings. If you removed the memory card and used it with another device after this happened, we recommend you select [No].

File name error

- The folder and file numbers have reached their maximum value. Set  [Photo Numbering] to [Reset] and delete all the photos on the memory card ( 106) or initialize it ( 40).

Initialize only using the camcorder

- There is a problem with the file system that prevents accessing the selected memory. Initialize the memory with this camcorder ( 40).

LCD Screen has been dimmed

- Hold  pressed for 2 seconds to restore the LCD screen to its previous brightness setting.

May not be possible to record movies on this memory card

- You may not be able to record movies on a memory card without a Speed Class rating. Replace the memory card with one rated Speed Class 2, 4, 6 or 10.

Mem. Card Number of scenes already at maximum

- The memory card already contains the maximum number of scenes (3,999 scenes); no further scenes can be copied onto the memory card. Delete some scenes ( 57) to free some space.

Mem. Card Unable to recognize the data

- The memory card contains scenes recorded in a different television system (PAL or SECAM). Play back the recordings in the memory card with the device originally used to record them.

Memory card cover is open

- After inserting a memory card, close the memory card slot cover ( 37).

Memory card is full

- The memory card is full. Delete some recordings ( 57, 106) to free some space or replace the memory card.

Memory card is write-protected

- The LOCK switch on the memory card is set to prevent accidental erasure. Change the position of the LOCK switch.

Need to recover files from the memory card. Change the position of the LOCK switch on the memory card.

- This message will appear the next time you turn on the camcorder if power supply was accidentally interrupted while the camcorder was writing on the memory card and later the position of the card's LOCK switch was changed to prevent erasure. Change the position of the LOCK switch.

No faces were detected in this scene

- The camcorder did not detect any faces in the scene displayed. Be sure to turn on face detection (📖 67) when shooting movies.

No memory card

- Insert a compatible memory card into the camcorder (📖 37).

No photos

- There are no photos to play back. Have fun taking some photos (📖 42, 59).

No scenes

- There are no scenes in the memory selected. Have fun shooting some video (📖 42).
- After selecting [Scenes with Faces] when narrowing down the scenes shown in the index screen: No scenes contain people's faces or no scenes were recorded using the face detection function.

Not enough available space

- Delete some recordings on the memory card (📖 57, 106) or select the [3Mbps] bit rate for the conversion to SD.

Number of scenes already at maximum

- The maximum number of scenes (3,999 scenes) has been reached. Delete some scenes (📖 57) to free some space.
- The playlist can contain a maximum of 999 scenes.

Playlist is full. Cannot divide the scene.

- Scenes cannot be divided when the playlist already contains 999 scenes. Delete some scenes from the playlist (📖 99).

Scene recorded using another device. Cannot divide the scene.

- Scenes recorded using another device cannot be divided with this camcorder.

Select the desired scene number

- A number of scenes have the same recording date but different file control information. This can occur for example when you edit photos and write the files back to the camcorder. Select a number to display the corresponding group of scenes.

Some  photos could not be deleted

- Protected photos () cannot be deleted. Remove the protection (📖 118).

Some scenes could not be added to the playlist.

- You may not be able to add to the playlist scenes recorded using another device.
- The playlist can contain a maximum of 999 scenes. If the playlist includes scenes recorded in MXP or FXP mode, the maximum number of scenes in the playlist may be less than 999. Delete some scenes from the playlist (📖 99).

Some scenes could not be converted

- Among the scenes selected for conversion to SD there are scenes recorded with another device using 24p frame rate. When converting scenes to SD, leave out scenes recorded using another device.

Some scenes could not be deleted

- Movies that were protected/edited with other devices cannot be deleted with this camcorder.

Some scenes were recorded using another device and cannot be copied.

- Scenes that were not recorded with this camcorder cannot be copied to memory card **B**.

Task in progress. Do not disconnect the power source.

- The camcorder is updating the memory. Wait until the operation ends and do not disconnect the compact power adapter or remove the battery pack.

The camcorder is set to photo mode

- You pressed **START/STOP** while recording photos (📷 mode). Set the camcorder to **📷** or **📹** mode to record movies.

This memory card contains scenes. Delete all scenes to use relay recording.

- Save your movies (📖 133) if necessary, and delete all the movies from the memory card (📖 57).

This photo cannot be displayed

- You may not be able to display photos taken with other devices or image files created or edited on a computer.

This **🔒** photo could not be deleted

- Protected photos (**🔒**) cannot be deleted. Remove the protection (📖 118).

This scene was recorded using another device and cannot be added to the playlist.

- Scenes that were not recorded with this camcorder cannot be added to the playlist.

This scene was recorded using another device and cannot be copied.

- Scenes that were not recorded with this camcorder cannot be copied to memory card **B**.

To record video on this memory card, it is recommended to use only the XP+/SP/LP recording modes

- Movies may not be recorded correctly on this memory card if the recording mode is set to MXP or FXP mode (📖 60).

To use the wireless function, insert the Eye-Fi card into slot B.

- You may have inserted the Eye-Fi card into memory card slot **A**. Insert it into memory card slot **B**.

To use this function change the camcorder's mode from  to **M**

- You pressed a button that cannot be used in  mode. Set the mode switch to **M** to set the camcorder to flexible recording mode.

Too many photos. Disconnect the USB cable.

- Disconnect the USB cable. Try using a memory card reader or decrease the number of photos on the memory card to fewer than 2,500 photos (printers, Windows computers), or 1,000 photos (Macintosh computers).
- If a dialog box appeared on the computer screen, close it. Disconnect the USB cable, and restore the connection after a short while.



Total play time is too long

- The playlist cannot be converted when its total playback time exceeds 2 hours and 30 minutes. Reduce the number of scenes in the playlist.

Unable to recognize the data

- You transferred data to the camcorder recorded in a different television system (PAL or SECAM). Play back the recordings with the device originally used to record them.

Unable to recover data

- Could not recover a corrupted file. Save your recordings ( 133) and initialize the memory using the [Complete Initialization] option ( 40).

Messages Related to the Optional DW100 DVD Burner

If an error message appears while the camcorder is connected to the optional DW-100 DVD Burner, refer to the following section and also to the instruction manual of the DVD Burner.

Cannot read the disc. Check the disc.

- During disc recording mode, this message can appear when a commercially available DVD disc (a DVD disc containing movies, software, etc.) or an 8 cm mini DVD disc is inserted. Replace with a brand new disc.
- During disc playback mode, this message can appear when a commercially available DVD disc or a brand new DVD disc is inserted. Replace with an AVCHD disc created with the DVD Burner.

Close the memory card slot cover

- The memory card slot cover is open. Close the cover after correctly inserting the memory card ( 37).

Connect the compact power adapter

- The camcorder is being powered by the battery pack. Connect the compact power adapter to the camcorder.

Disc access failure. Check the disc.

- There was an error when reading the disc or attempting to write onto it.
- This message can appear also if condensation has formed (☞ 199). Wait until the DVD burner dries completely before resuming use.
- The disc may be dirty or not correctly loaded. Try removing the disc and reinserting it after cleaning the recording surface with a clean, soft cloth. If the problem persists, replace with a different disc.

Error reading the data

- Check that the USB cable was not accidentally disconnected.

No disc

- Insert a disc into the DVD Burner.
- This message can appear also if condensation has formed (☞ 199). Wait until the DVD burner dries completely before resuming use.

No photos

- There are no photos to add to the disc.

No scenes

- There are no scenes to add to the disc.

No scenes left to add

- There are no scenes that have not already been added to discs created previously.

Operation canceled

- The USB cable was disconnected and the operation was canceled. Check the USB connection.
- The scenes selected to be written on the disc include scenes recorded in MXP mode. Add to the playlist in advance only those scenes recorded in other recording modes and create the disc from the [Playlist] index screen.

Unable to recover data

- Could not recover a corrupted file. Save your recordings (☞ 133) and initialize the memory using the [Complete Initialization] option (☞ 40).

Direct Print Related Messages

Data transfer error

- Cancel printing, disconnect the USB cable and turn off the printer. After a while, turn the printer back on and reconnect the USB cable.
- You attempted to print from a memory card that contains a large number of photos. Reduce the number of photos.

File error

- You attempted to print a photo that was recorded with another camcorder, has a different compression, or was edited on a computer.

Hardware error

- Cancel printing. Turn off the printer and turn it back on.
- Check the printer status.
- Ink tank errors have occurred. Replace the ink tank.

Ink absorber full

- Touch [Continue] to resume printing. Consult a Canon Service Center (refer to the list included with the printer) to replace the ink absorber.

Ink error

- The ink level cannot be detected correctly or the ink cartridge is out of ink. Replace the ink cartridge.

Low ink level

- The ink cartridge needs to be replaced soon. Touch [Continue] to restart printing.

No ink

- The ink cartridge is not inserted or is out of ink. Replace the ink cartridge.

No paper

- Paper is not correctly inserted or there is no paper.

Paper error

- There is a problem with the paper. The paper is not correctly loaded or the paper size is wrong.
- If the paper output tray is closed, open it to print.

Paper jam

- The paper jammed during printing. Touch [Stop] to cancel printing. After removing the paper, set some paper again and retry printing.

Paper lever error

- Paper lever error occurred. Adjust the paper selection lever to the proper position.

Print head not installed

- No print head is installed in the printer or the print head is defective.

Printer cover open

- Close the printer cover securely.

Printer error

- A malfunction has occurred that may require repairs. (Canon PIXMA printers: the printer's green power lamp and orange error lamp flash alternately.)
- Disconnect the USB cable and turn off the printer. Unplug the printer's power cord from the power outlet and contact the appropriate customer support center or service center.

Printer in use

- The printer is in use. Check the printer status.

Printing error

- The printer does not support the paper size selected for [Paper Settings]. Set [Paper Settings] to [Default] or a paper size supported by the printer used.
- Cancel printing, disconnect the USB cable and turn off the printer. After a while, turn the printer back on and reconnect the USB cable. Check the printer status.

NOTES

About Canon PIXMA/SELPHY DS Printers: If the printer's error indicator flashes or an error message appears on the printer's operation panel, refer to the printer's instruction manual.

- If you cannot solve the problem even after consulting this list and the printer's instruction manual, contact the closest Canon Service Center (refer to the list included with the printer).

Handling Precautions

Camcorder

Be sure to observe the following precautions to ensure maximum performance.

- **Save your recordings periodically.** Make sure to transfer your recordings to an external device such as a computer or digital video recorder (📖 130) and save them on a regular basis. This will protect your important recordings in case of damage and create more free space on the memory. Canon shall not be liable for any data loss.
- Do not carry the camcorder by the LCD panel or the viewfinder (**HFS21** only). Be careful when closing the LCD panel. When using a wrist strap, do not allow the camcorder to swing and hit an object.
- **Handle the touch screen with care.** Do not apply excessive force and do not use ballpoint pens or other hard-tipped tools to operate the touch screen. This may damage the touch screen's surface or the pressure-sensitive layer beneath it.
- Do not attach protective film on the touch screen. The touch screen's operation is based on detecting applied pressure, so you may not be able to correctly operate the touch screen with an additional protective layer.
- Do not leave the camcorder in places subject to high temperatures (like the inside of a car parked under direct sunlight), or high humidity.
- Do not use the camcorder near strong electromagnetic fields such as above TVs, near plasma TVs or mobile phones.
- Do not point the lens or the viewfinder (**HFS21** only) at strong light sources. Do not leave the camcorder pointed at a bright subject.
- Do not use or store the camcorder in dusty or sandy places. The camcorder is not waterproof – avoid also water, mud or salt. If any of the above should get into the camcorder it may damage the camcorder and/or the lens.
- Be careful of heat generated by lighting equipment.
- Do not disassemble the camcorder. If the camcorder does not function properly, consult qualified service personnel.
- Handle the camcorder with care. Do not subject the camcorder to shocks or vibration as this may cause damage.

- When mounting the camcorder on a tripod, make sure that the tripod's fastening screw is shorter than 5.5 mm (0.2 in.). Using other tripods may damage the camcorder.

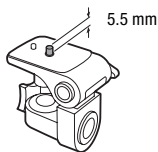

- **When recording movies, try to get a calm, stable picture.** Excessive camcorder movement while shooting and extensive use of fast zooms and panning can result in jittery scenes. In extreme cases, the playback of such scenes may result in visually induced motion sickness. If you experience such a reaction, stop the playback immediately and take a rest break as necessary.

Long-term storage

If you do not intend to use the camcorder for a long time, store it in a place free of dust, in low humidity, and at temperatures not higher than 30 °C (86 °F).

Battery Pack

DANGER!

Treat the battery pack with care.

- Keep it away from fire (or it might explode).
 - Do not expose the battery pack to temperature higher than 60 °C (140 °F). Do not leave it near a heater or inside a car in hot weather.
 - Do not try to disassemble or modify it.
 - Do not drop it or subject it to shocks.
 - Do not get it wet.
- Dirty terminals may cause a poor contact between the battery pack and the camcorder. Wipe the terminals with a soft cloth.



Long-term storage

- Store battery packs in a dry place at temperatures no higher than 30 °C (86 °F).
- To extend the battery life of the battery pack, discharge it completely before storing it.
- Charge and discharge all your battery packs fully at least once a year.

Remaining battery time

If the remaining battery time displayed is not correct, charge the battery pack fully. Still, the correct time may not be displayed if a fully charged battery pack is used continuously in high temperatures or it is left unused for long periods of time. Also, the correct remaining time may not be displayed, depending on the battery life. Use the time shown on the screen as an approximation.

Regarding the use of non-Canon battery packs

- For your safety, battery packs that are not genuine Canon battery packs will not be charged even if you attach them to this camcorder or to the optional CG-800 Battery Charger.
- We recommend using genuine Canon battery packs bearing the Intelligent System mark.  **Intelligent Li-ion Battery**
- If you attach to the camcorder battery packs that are not genuine Canon battery packs,  will appear and the remaining battery time will not be displayed.

Memory Card

- We recommend backing up the recordings on the memory card onto your computer. Data may be corrupted or lost due to memory card defects or exposure to static electricity. Canon shall not be liable for lost or corrupted data.
- Do not touch or expose the terminals to dust or dirt.
- Do not use memory cards in places subject to strong magnetic fields.
- Do not leave memory cards in places subject to high humidity and high temperature.
- Do not disassemble, bend, drop, or subject memory cards to shocks and do not expose them to water.
- Check the direction before inserting the memory card. Forcing a memory card into the slot if it is not correctly oriented may damage the memory card or the camcorder.
- Do not attach any labels or stickers on the memory card.

- Secure Digital (SD) memory cards have a physical switch to prevent writing on the card so as to avoid the accidental erasure of the card's content. To write-protect the memory card set the switch to the LOCK position.



Built-in Rechargeable Lithium Battery

The camcorder has a built-in rechargeable lithium battery to keep the date/time and other settings. The built-in lithium battery is recharged while you use the camcorder; however, it will discharge completely if you do not use the camcorder for about 3 months.

To recharge the built-in lithium battery: Connect the compact power adapter to the camcorder and leave it connected for 24 hours with the camcorder off.

Lithium Button Battery

WARNING!

- The battery used in this device may present a fire or chemical burn hazard if mishandled.
 - Do not disassemble, modify, immerse in water, heat above 100 °C (212 °F) or incinerate the battery.
 - Replace with a CR2025 battery made by Panasonic, Hitachi Maxell, Sony, Sanyo, or with Duracell2025. Use of other batteries may present a risk of fire or explosion.
 - Do not insert the battery into the mouth. If swallowed, seek medical assistance immediately. The battery case may break and the battery fluids may cause internal injuries.
 - Keep the battery out of the reach of children.
 - Do not recharge, short-circuit or insert the battery in the wrong direction.
 - Dispose of the used battery according to applicable recycling regulations.
- Do not pick up the battery using tweezers or other metal tools, as this will cause a short circuit.

- Wipe the battery with a clean dry cloth to ensure proper contact.
- **For California, USA only:** The lithium battery included contains Perchlorate Material – special handling may apply.
See www.dtsc.ca.gov/hazardouswaste/perchlorate for details.

Disposal

When you delete movies or initialize the memory, only the file allocation table is altered and stored data is not physically erased. Take the necessary precautions when you dispose of the camcorder or memory card, for example by physically damaging it to prevent the leakage of private data.

If giving the camcorder or memory card to another person, initialize the built-in memory (**HFS21/S20** only) or memory card using the [Complete Initialization] option (📖 40). Fill it up with unimportant recordings, and then initialize it again using the same option. This makes recovering the original recordings very difficult.

Maintenance/Others

Cleaning

Camcorder Body

- Use a soft, dry cloth to clean the camcorder body. Never use chemically treated cloths or volatile solvents such as paint thinner.

Lens, Viewfinder (HFS21 only) and Instant AF Sensor

- If the lens surface or Instant AF sensor is dirty, autofocus may not work properly.
- Remove any dust or dirt particles using a non-aerosol type blower brush.
- Use a clean, soft lens-cleaning cloth to gently wipe the lens or the viewfinder (HFS21 only). Never use tissue paper.

LCD Touch Screen

- Clean the LCD touch screen using a clean, soft lens-cleaning cloth.
- Condensation may form on the surface of the screen when the temperature changes suddenly. Wipe it with a soft dry cloth.

Condensation

Moving the camcorder rapidly between hot and cold temperatures may cause condensation (water droplets) to form on its internal surfaces. Stop using the camcorder if condensation is detected. Continued use may damage the camcorder.

Condensation may form in the following cases:

- When the camcorder is moved quickly from cold to warm places
- When the camcorder is left in a humid room
- When a cold room is heated rapidly

To avoid condensation

- Do not expose the camcorder to sudden or extreme changes in temperature.
- Remove the memory card and battery pack. Then, place the camcorder in an airtight plastic bag and let it adjust gradually to temperature changes before removing it from the bag.

When condensation is detected

The camcorder automatically shuts off.

The precise time required for water droplets to evaporate will vary depending on the location and weather conditions. As a general rule, wait for 2 hours before resuming use of the camcorder.

Using the Camcorder Abroad

Power Sources

You can use the compact power adapter to operate the camcorder and to charge battery packs in any country with power supply between 100 and 240 V AC, 50/60 Hz. Consult a Canon Service Center for information on plug adapters for overseas use.

Playback on a TV Screen

You can only play back your recordings on TVs compatible with the NTSC system. NTSC is used in the following regions/countries:

Americas: All of North America and Central America; most Caribbean islands (except in French territories like Guadeloupe and Martinique); most of South America (except in Argentina, Brazil and Uruguay). **Asia:** Only in Japan, the Philippines, South Korea, Taiwan and Myanmar. **Oceania:** US territories (Guam, American Samoa, etc.) and some Pacific islands like Micronesia, Samoa and Tonga.

Accessories (Availability differs from area to area)

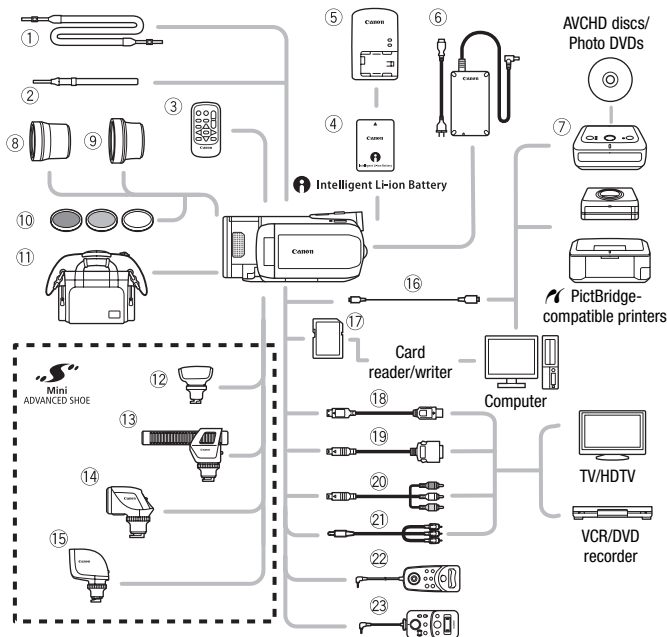

Optional accessories not listed below are described in more detail in the following pages.

- | | |
|--------------------------------|----------------------------------|
| ① SS-600/SS-650 Shoulder Strap | ⑲ DTC-100 D Terminal Cable |
| ② WS-20 Wrist Strap | ⑳ CTC-100 Component Cable |
| ③ WL-D89 Wireless Controller | CTC-100/S Component Cable* |
| ⑥ CA-570 Compact Power Adapter | ㉑ STV-250N Stereo Video Cable |
| ⑦ DW-100 DVD Burner | ㉒ ZR-1000 Zoom Remote Controller |
| ⑯ IFC-300PCU USB Cable | ㉓ ZR-2000 Zoom Remote Controller |
| ⑰ Memory card | |

* Supplied with the camcorder; not available as an optional accessory.

i NOTES

- Accessories that are compatible with the Advanced Accessory Shoe cannot be attached to this camcorder. Look for the **Mini ADVANCED SHOE** logo to ensure compatibility with the mini advanced shoe.

Optional Accessories

Call or visit your local retailer/dealer for genuine Canon video accessories. You can also obtain genuine accessories for your Canon camcorder by calling: 1-800-828-4040, Canon U.S.A. Information Center.

Use of genuine Canon accessories is recommended.

This product is designed to achieve excellent performance when used with genuine Canon accessories. Canon shall not be liable for any damage to this product and/or accidents such as fire, etc., caused by the malfunction of non-genuine Canon accessories (e.g., a leakage and/or explosion of a battery pack). Please note that this warranty does not apply to repairs arising out of the malfunction of non-genuine Canon accessories, although you may request such repairs on a chargeable basis.

④ Battery Packs

When you need extra battery packs, select one of the following models: BP-808, BP-809(B)*, BP-809(S)*, BP-819, or BP-827.

* Please note that the shape/color of this battery does not match the external design of the camcorder.

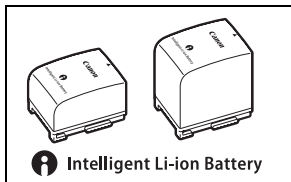

When you use battery packs bearing the Intelligent System mark, the camcorder will communicate with the battery and display the remaining usage time (accurate to 1 minute). You can only use and charge these battery packs with camcorders and chargers compatible with Intelligent System.

⑤ CG-800 Battery Charger

Use the battery charger to charge the battery packs. It plugs directly into a power outlet without a cable.

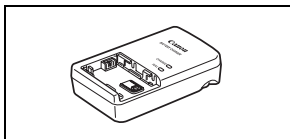

Charging, Recording and Playback Times

The charging times given in the following table are approximate and vary according to charging conditions and initial charge of the battery pack.

Battery pack→	BP-808 BP-809	BP-819	BP-827
Charging conditions↓			
Using the camcorder	150 min.	260 min.	385 min.
Using the CG-800 Battery Charger	105 min.	190 min.	260 min.

Recording and playback times given in the following tables are approximate and vary according to recording mode and charging, recording or playback conditions. The effective usage time of the battery pack may decrease when recording in cold surroundings, when using the brighter screen settings, etc.

HFS21/S20 Using the built-in memory

Battery pack	Recording mode	Recording (maximum)		Recording (typical)*		Playback
		LCD	Viewfinder**	LCD	Viewfinder**	LCD
BP-808 BP-809	MXP	80 min.	95 min.	55 min.	60 min.	125 min.
	FXP	80 min.	95 min.	55 min.	60 min.	125 min.
	XP+	80 min.	95 min.	55 min.	60 min.	125 min.
	SP	80 min.	95 min.	55 min.	60 min.	130 min.
	LP	85 min.	100 min.	55 min.	60 min.	130 min.
BP-819	MXP	165 min.	190 min.	105 min.	120 min.	265 min.
	FXP	165 min.	190 min.	105 min.	120 min.	265 min.
	XP+	165 min.	195 min.	105 min.	120 min.	265 min.
	SP	170 min.	200 min.	110 min.	125 min.	265 min.
	LP	175 min.	200 min.	110 min.	125 min.	265 min.
BP-827	MXP	255 min.	290 min.	170 min.	185 min.	380 min.
	FXP	255 min.	290 min.	170 min.	185 min.	385 min.
	XP+	265 min.	295 min.	170 min.	190 min.	385 min.
	SP	270 min.	305 min.	175 min.	195 min.	405 min.
	LP	275 min.	315 min.	175 min.	195 min.	405 min.

* Approximate times for recording with repeated operations such as start/stop, zooming, and power on/off.

** **HFS21** only.

Using a memory card

Battery pack	Recording mode	Recording (maximum)		Recording (typical)*		Playback
		LCD	Viewfinder**	LCD	Viewfinder**	LCD
BP-808 BP-809	MXP	85 min.	95 min.	55 min.	60 min.	130 min.
	FXP	85 min.	95 min.	55 min.	60 min.	130 min.
	XP+	85 min.	100 min.	55 min.	60 min.	130 min.
	SP	90 min.	100 min.	55 min.	60 min.	135 min.
	LP	90 min.	100 min.	55 min.	60 min.	135 min.
BP-819	MXP	170 min.	195 min.	105 min.	120 min.	265 min.
	FXP	170 min.	195 min.	105 min.	125 min.	265 min.
	XP+	175 min.	200 min.	110 min.	125 min.	265 min.
	SP	175 min.	200 min.	105 min.	125 min.	270 min.
	LP	175 min.	200 min.	105 min.	125 min.	275 min.
BP-827	MXP	265 min.	295 min.	170 min.	190 min.	390 min.
	FXP	265 min.	300 min.	175 min.	190 min.	400 min.
	XP+	275 min.	305 min.	175 min.	195 min.	405 min.
	SP	275 min.	310 min.	175 min.	195 min.	410 min.
	LP	275 min.	315 min.	175 min.	195 min.	410 min.

* Approximate times for recording with repeated operations such as start/stop, zooming, and power on/off.

** **HFS21** only.

⑧ TL-H58 Tele-converter

This Tele-converter lens increases the focal length of the camcorder lens by a factor of 1.5.

- The image stabilizer is not as effective when the Tele-converter is attached.
- The minimum focusing distance at full telephoto with the TL-H58 is 2.3 m (7.5 ft.).
- When the Tele-converter is attached, a shadow may appear in the picture when you use the flash.

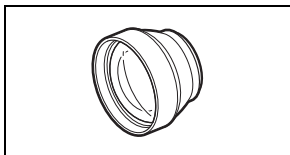

⑨ **WD-H58 Wide-converter**

This Wide-converter lens decreases focal length by a factor of 0.7, giving you a wide perspective for indoor shots or panoramic views.

- When the Wide-converter is attached, a shadow may appear in the picture when you use the flash.

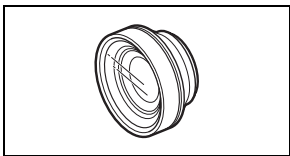

⑩ **Protect Filter 58 mm, ND4-L Filter 58 mm, ND8-L Filter 58 mm**

Neutral density and MC protector filters help you to control difficult lighting conditions.

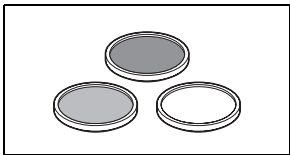

⑪ **SC-2000 Soft Carrying Case**

A handy camcorder bag with padded compartments and plenty of space for accessories.



⑫ **SM-V1 Surround Microphone**

Use 5.1ch surround sound to add a sense of presence to your movies. You can link the surround sound to the zoom position or use the microphone as a highly directional shotgun microphone (monaural).

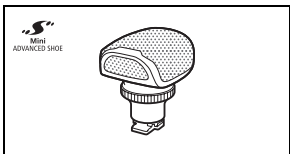

⑬ **DM-100 Directional Stereo Microphone**

This highly sensitive, super-directional microphone attaches to the camcorder's mini advanced shoe. It can be used as directional microphone (monaural) or stereo microphone.

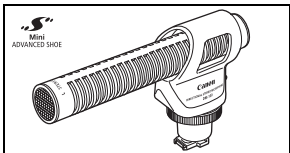

⑭ **VL-5 Video Light**

This video light enables you to record brightly in color even in dark places. It attaches to the camcorder's mini advanced shoe for cable-free operation.

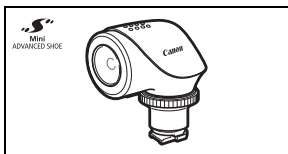

⑮ **VFL-2 Video Flash Light**

This video flash light allows you to record photos and movies even at night or in dark places. It attaches to the camcorder's mini advanced shoe for cable-free operation.

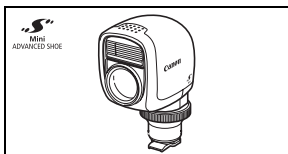

⑰ **HTC-100 HDMI Cable**

Use this cable to connect the camcorder to an external device using an all-digital connection, allowing you to enjoy play-back at the highest quality. This cable sends both video and audio signals.

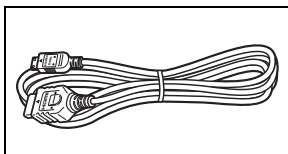

This mark identifies genuine Canon video accessories. When you use Canon video equipment, we recommend Canon-brand accessories or products bearing the same mark.



Product Codes

Provided Accessories

CA-570 Compact Power Adapter	8468A002AA
BP-808 Battery Pack	2740B002AA
WL-D89 Wireless Controller	D83-0790-000
STV-250N Stereo Video Cable	3067A002AA (D82-0590-002)
IFC-300PCU USB Cable	6906A001AA

Optional Accessories

BP-809 Battery Pack	2588B003AA (silver), 2588B004AA (black)
BP-819 Battery Pack	2589B002AA
BP-827 Battery Pack	3185B002AA
CG-800 Battery Charger	2590B002AA
TL-H58 Tele-converter	3573B001AA
WD-H58 Wide-converter	3572B001AA
Protect Filter 58 mm	2595A002AA
ND4-L Filter 58 mm	2596A002AA
ND8-L Filter 58 mm	2597A002AA
VL-5 Video Light	3186B001AA
VFL-2 Video Flash Light	3574B001AA
SM-V1 Surround Microphone	4464B001AA
DM-100 Directional Stereo Microphone	2591B002AA
ZR-1000 Zoom Remote Controller	3089A002AA
ZR-2000 Zoom Remote Controller	0973B002AA
HTC-100 HDMI Cable	2384B001AA
CTC-100 Component Cable	1719B001AA
SS-650 Shoulder Strap	3123A001AA
SS-600 Shoulder Strap	3122A001AA
WS-20 Wrist Strap	3118A002AA
SC-2000 Soft Carrying Case	9389A001AA

Specifications

VIXIA HF S21 / VIXIA HF S20 / VIXIA HF S200

◆ — Values given are approximate figures.

System

• Recording System

Movies: AVCHD Video compression: MPEG-4 AVC/H.264;
Audio compression: Dolby Digital 2ch; Dolby Digital 5.1ch*
* Only when using the optional SM-V1 Surround Microphone.

Photos: DCF (Design rule for Camera File system), compatible with Exif* Ver. 2.2 and with DPOF**
Image compression: JPEG (Super Fine, Fine, Normal)

* This camcorder supports Exif 2.2 (also called "Exif Print"). Exif Print is a standard for enhancing the communication between camcorders and printers. By connecting to an Exif Print-compliant printer, the camcorder's image data at the time of shooting is used and optimized, yielding extremely high quality prints.

** Only photos recorded on a memory card.

• Television System

1080/60i* or 1080/24p (only recordings made with the [24F] frame rate)

* Recordings made with the [PF24], [PF30] frame rate are converted and recorded on the memory as 60i.

• Recording Media

- **HFS21/S20** Built-in memory: **HFS21** 64 GB, **HFS20** 32 GB
- SD or SDHC (SD High Capacity) memory card (not included)

• Maximum Recording Time◆

HFS21 64 GB built-in memory:

MXP mode: 5 hr. 55 min. **FXP** mode: 8 hr. 20 min. **XP+** mode: 11 hr. 30 min.
SP mode: 19 hr. 10 min. **LP** mode: 24 hr. 30 min.

HFS20 32 GB built-in memory:

MXP mode: 2 hr. 55 min. **FXP** mode: 4 hr. 10 min. **XP+** mode: 5 hr. 45 min.
SP mode: 9 hr. 35 min. **LP** mode: 12 hr. 15 min.

Commercially available 16 GB memory card:

MXP mode: 1 hr. 25 min. **FXP** mode: 2 hr. 5 min. **XP+** mode: 2 hr. 50 min.
SP mode: 4 hr. 45 min. **LP** mode: 6 hr. 5 min.

• Image Sensor

1/2.6-inch CMOS, 8,590,000 pixels◆

Effective pixels◆: Movies: 6,010,000 pixels
(using Digital Tele-converter): 2,070,000 pixels
Photos (**L**, **M**, **S**): 8,020,000 pixels
Photos (**LW**, **MW**): 6,010,000 pixels

- **LCD Touch Screen:** 3.5 in., wide, TFT color, 922,000 dots[♦], touch operation
- **[HF521] Viewfinder:** 0.27 in., wide, TFT color, 123,000 dots[♦]
- **Microphone:** Stereo electret condenser microphone
- **Lens**
 $f=6.4\text{--}64$ mm, F/1.8–3.0, 10x optical zoom, iris aperture
 35 mm equivalent[♦]: Movies: 43.5 – 435 mm
 Photos (**L**, **M**, **S**): 39.9 – 399 mm
 Photos (**LW**, **MW**): 43.5 – 435 mm
- **Lens Configuration:** 11 elements in 9 groups (2 aspheric elements)
- **AF System**
 Autofocus (TTL + external distance sensor when set to [Instant AF]) or Manual focus
- **Filter Diameter:** 58 mm
- **Minimum Focusing Distance**
 1 m (3.3 ft.); 1 cm (0.39 in.) at full wide angle
- **White Balance**
 Auto white balance, Custom white balance or Preset white balance settings:
 Daylight, Shade, Cloudy, Tungsten, Fluorescent, Fluorescent H
- **Minimum Illumination**
 0.3 lx ([Low Light] recording program, Shutter speed at 1/2)
 4 lx ([Programmed AE] recording program, Shutter speed at 1/30, Auto slow shutter [On])
- **Recommended Illumination:** More than 100 lx
- **Image Stabilization:** Optical-Shift Image Stabilizer
- **Size of Video Recordings**
MPX, FXP mode: 1920 x 1080 pixels; **XP+**, **SP**, **LP** mode: 1440 x 1080 pixels
- **Size of Photos**
 mode: **LW** 3264 x 1840, **L** 3264 x 2456, **M** 1920 x 1440, **S** 640 x 480 pixels
 Simultaneous recording: **LW** 3264 x 1840, **MW** 1920 x 1080 pixels
 Capturing photos from video: **MW** 1920 x 1080 pixels

Terminals

- **AV OUT/ Terminal**
 \varnothing 3.5 mm minijack; output only (dual purpose terminal also for headphones stereo output)
 Video: 1 Vp-p / 75 Ω unbalanced
 Audio: –10 dBV (47 k Ω load) / 3 k Ω or less
- **USB Terminal:** mini-B, USB 2.0 (Hi-Speed USB)
- **COMPONENT OUT Terminal (proprietary mini-D terminal)**
 Luminance (Y): 1 Vp-p / 75 Ω ; Chrominance (P_B/P_R (C_B/C_R)): ± 350 mV / 75 Ω
 1080i (D3) compatible; output only
- **HDMI OUT Terminal**
 HDMI mini connector; output only; compatible with HDMI-CEC and x.v.Color

- **MIC Terminal**
 Ø 3.5 mm stereo minijack
 -57 dBV (with 600 Ω microphone) / 5 kΩ or more
- **REMOTE Terminal**
 Ø 2.5 mm stereo minijack

Power/Others

- **Power supply (rated)**
 7.4 V DC (battery pack), 8.4 V DC (compact power adapter)
- **Power consumption** ♦
HF521/S20 4.1 W (SP mode, AF on, built-in memory, LCD normal brightness)
 4.0 W (SP mode, AF on, memory card, LCD normal brightness)
HF521 3.6 W (SP mode, AF on, built-in memory, viewfinder)
HF521 3.5 W (SP mode, AF on, memory card, viewfinder)
- **Operating temperature:** 0 – 40 °C (32 – 104 °F)
- **Dimensions** ♦ [W x H x D] (excluding the grip belt)
HF521 75 x 74 x 148 mm (3.0 x 2.9 x 5.8 in.)
HF520/S200 75 x 74 x 140 mm (3.0 x 2.9 x 5.5 in.)
- **Weight** ♦ (camcorder body only)
HF521 470 g (1.0 lb.)
HF520/S200 460 g (16.2 oz.)

CA-570 Compact Power Adapter

- **Power supply:** 100 – 240 V AC, 50/60 Hz
- **Rated output / consumption:** 8.4 V DC, 1.5 A / 29 VA (100 V) – 39 VA (240 V)
- **Operating temperature:** 0 – 40 °C (32 – 104 °F)
- **Dimensions** ♦: 52 x 29 x 90 mm (2.1 x 1.1 x 3.5 in.)
- **Weight** ♦: 135 g (4.8 oz.)

BP-808 Battery Pack

- **Battery type**
 Rechargeable lithium ion battery, compatible with Intelligent System
- **Rated voltage:** 7.4 V DC
- **Operating temperature:** 0 – 40 °C (32 – 104 °F)
- **Battery capacity:** 890 mAh
- **Dimensions** ♦: 30.7 x 23.3 x 40.2 mm (1.2 x 0.92 x 1.6 in.)
- **Weight** ♦: 46 g (1.6 oz)

About the music files

The specifications of the music files compatible with the camcorder are as follows.

Audio encoding: Linear PCM

Audio sampling: 48 kHz, 16 bits, 2 channels

Minimum length: 1 second

File extension: WAV

The music data is saved in the memory under the following folder structure.

HFS21/S20 In the built-in memory:

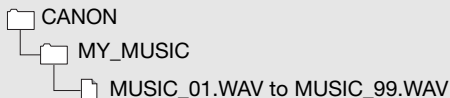

On the memory card:

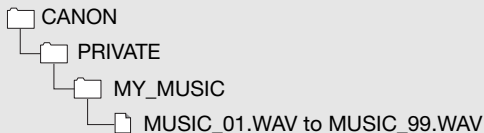

Weight and dimensions are approximate. Errors and omissions excepted.
The information in this manual is verified as of January 2010. Subject to change without notice.

Index

- 24p Cinema Mode 63
- 3D Flip View 55
- A**
- Abroad, using the camcorder 200
- AF-assist lamp 112
- AGC (automatic gain) limit 76
- Aperture (f number) 71
- Aspect ratio of a connected TV
(TV type) 164
- Audio recording level 83
- Auto exposure bracketing 113
- Auto slow shutter 158
- Autofocus (AF)
 - AF frame (9-point AiAF/
Center point) 157
 - Instant AF/Normal AF 157
- Automatic backlight correction 75
- Av (recording program) 71
- AV OUT/ \square terminal 85, 125, 127
- AVCHD specifications 8
- B**
- Background music 93
- Battery pack
 - Battery information 168, 174
 - Charging 22
 - Remaining charge
indicator 174
- Beach (recording program) 62
- Built-in backup battery 197
- C**
- Calendar 56
- Camcorder supplemental disc 18
- Capturing photos/video snapshot
scenes from a movie 100
- Cine Mode (recording program) 63
- Color bars/Test tone 162
- COMPONENT
OUT terminal 125, 127
- Condensation 199
- Connections to external
devices 126
- Continuous shooting 113
- Copying
 - Movies 130
 - Photos 131
- Custom key/dial 89
- D**
- Data code 97, 164
- Date and time 34
- Deleting
 - Movies 57, 99
 - Photos 106, 109
- Digital effects 70
- Digital tele-converter 80
- Dividing scenes 102
- Drive mode 113
- Dual Shot 30
- E**
- Edit panel 32, 154
- Error messages 183
- External microphone 87
- Eye-Fi card 150
- F**
- Face detection
 - Playback 56
 - Recording 67
- Fireworks (recording program) 63
- Flash 111
- Flexible recording 30
- Focus assistance 158
- Focus priority 157
- Frame rate 63, 162
- FUNC. panel 32, 152
- H**
- HD to SD conversion 140, 146
- HDMI OUT terminal 125, 126

HDMI-CEC	168
Headphones	85
Highlight AE	75
Histogram	118

I

Image effects	81
Image stabilizer	64
Index screens	49
Index screen selection	53
Showing some/ all of the scenes	56
Initialization (built-in memory*/ memory card)	40

L

Language	35
LCD screen dimmer	167
LCD touch screen	26, 29
Light metering mode	115
Low light (recording program)	62

M

Magnifying photos	117
Maintenance	199
Manual exposure	74
Manual focus	76
Markers	159
Memory card	36, 196
MIC terminal	88
Microphone attenuator	158, 159
Mini advanced shoe	86
Mini video light	82
Mode switch	30

N

Night scene (recording program)	62
Notification sounds	167

O

Onscreen display selection	97
Onscreen icons	170

P

P (recording program)	71
Peaking	78
Photo numbers	163
Photo quality	109
Photo size	109
Playback	
Movies	49
Photos	104
Playlist	98
Portrait (recording program)	62
Power saving	45
Powered IS	65
Pre-recording	66
Print order	123
Printing photos	121
Progressive frame rates	
PF24, 24F, PF30	162, 174
Protecting photos	118

Q

Quick Start	47
-------------	----

R

Recording	
Movies	42, 59
Photos	42, 108
Recording mode	60
Recording programs	61, 63, 71
Recording time	61
Relay recording	39
Remote sensor	25
REMOTE terminal	90
Resetting all camcorder settings	169
Reviewing photos	163
Rotating photos	117, 163

* **HF521/S20** only.

S

Saving recordings	130
Creating discs	135, 140
Transferring to a computer	133
Using external video recorders	145
Selecting the memory	
for playback	53
for recording	38
Self timer	83
Serial number	20
Setup menus	33, 156
Shutter speed	71
Simultaneous recording	114
Slideshow	116
Smart AUTO mode	43
Snow (recording program)	62
Sports (recording program)	62
Spotlight (recording program)	62
Sunset (recording program)	62
Surround sound 5.1ch	87

T

Telephoto	46
Time zone/DST	35
Timeline	91
Touch & Track	68
Touch AE	74
Touch AF	76
Tripod	195
Troubleshooting	175
Tv (recording program)	71

U

Uploading movies to video sharing	
Web sites	146
USB terminal	125, 128

V

Video snapshot	69
Viewfinder**	28
Volume	51, 86

W

White balance	79
Wide angle	46
Wind screen	158
Wireless controller	24

Z

Zebra pattern	75
Zoom	46
Digital zoom	157
Zoom speed	46, 156

** **HFS21** only.

CANON CONSUMER DIGITAL VIDEO EQUIPMENT LIMITED WARRANTY FOR THE UNITED STATES

The limited warranty set forth below is given by Canon U.S.A., Inc. ("Canon USA") with respect to Canon Consumer Digital Video Equipment (the "Equipment") purchased in the United States. This limited warranty is only effective upon presentation of your Bill of Sale or other proof of purchase.

The Equipment is warranted under normal, non-commercial, personal use, against defective materials or workmanship as follows:

Parts: Defective parts will be exchanged for new parts or comparable rebuilt parts for a period of ONE YEAR from the date of original purchase, except for a defective Video Head, which will be exchanged for a period of three months from the date of purchase.

Labor: For a period of ONE YEAR from the date of original purchase, labor will be provided free of charge by our factory service centers or designated service facilities located in the United States.

When returning Equipment under this warranty, you must pre-pay the shipping charges, and you must enclose the Bill of Sale or other proof of purchase with a complete explanation of the problem. During the ONE-YEAR warranty period, repairs will be made and the Equipment will be return-shipped to you free of charge. For repairs after the warranty period is over, you will be given an estimate of the cost of repair and an opportunity to approve or disapprove of the repair expense before it is incurred. If you approve, repairs will be made and the Equipment will be return-shipped to you. (shipping charges apply). If you disapprove, we will return-ship the equipment at no charge to you.

Non-Canon brand peripheral equipment and software which may be distributed with, or factory loaded on, the Equipment, are sold "AS IS" without warranty of any kind by Canon USA, including any implied warranty regarding merchantability or fitness for a particular purpose. The sole warranty with respect to such non-Canon brand items is given by the manufacturer or producer thereof. If the Equipment contains a hard disk drive, Canon USA recommends that data stored on that drive be duplicated or backed up to prevent its loss in the event of failure or other malfunction of such drive.

Canon USA shall have no responsibility under this limited warranty for use of the Equipment in conjunction with incompatible peripheral equipment and incompatible software.

In order to obtain warranty service, contact the authorized Canon retail dealer from whom you purchased the Equipment or call the CANON INFORMATION CENTER AT 1-800-OK-CANON). You will be directed to the nearest service facility for your Equipment.

This Limited Warranty covers all defects encountered in normal use of the Equipment and does not apply in the following cases:

- A) Loss or damage to the Equipment due to abuse, mishandling, accident, improper maintenance, or failure to follow operating instructions;
- B) If the Equipment is defective as a result of leaking batteries, sand, dirt or water damage;
- C) If defects or damages are caused by the use of unauthorized parts or by service other than by Canon USA's factory service centers or authorized service facilities;
- D) If the Equipment is used for commercial or industrial use.

This Limited Warranty does not cover cabinet (exterior finish), video cassette tape, head cleanings, nor does it apply to Equipment purchased outside the United States. This warranty does not cover units sold to rental firms, military operations, hotels, schools, hospitals or for other commercial, industrial, or institutional applications.

These uses are covered only by such specific warranty as Canon may issue with such sales.

This Limited Warranty does not apply to accessories or consumables for the Equipment, which are sold "AS IS", without warranty of any kind by Canon USA.

Please retain this warranty card and your Bill of Sale as a permanent record of your purchase. This card is most important in order to be sure you are contacted right away should there be a safety inspection, modification or product recall under applicable laws or regulations.

NO IMPLIED WARRANTY, INCLUDING MERCHANTABILITY AND FITNESS FOR A PARTICULAR PURPOSE APPLIES TO THIS EQUIPMENT AFTER THE APPLICABLE PERIOD OF EXPRESS WARRANTY OR GUARANTY, EXCEPT AS MENTIONED ABOVE, GIVEN BY ANY PERSON, FIRM OR CORPORATION WITH RESPECT TO THIS EQUIPMENT SHALL BIND THE UNDERSIGNED (SOME STATES DO NOT ALLOW LIMITATIONS ON HOW LONG AN IMPLIED WARRANTY LASTS, SO THE ABOVE LIMITATION OR EXCLUSION MAY NOT APPLY TO YOU). CANON USA SHALL NOT BE LIABLE FOR LOSS OF REVENUES OR PROFITS, EXPENSE FOR SUBSTITUTE EQUIPMENT OR SERVICE, STORAGE CHARGES,

LOSS OR CORRUPTION OF DATA, INCLUDING WITHOUT LIMITATION, LOSS OR CORRUPTION OF DATA STORED ON THE EQUIPMENT'S HARD DRIVE, OR ANY OTHER SPECIAL, INCIDENTAL OR CONSEQUENTIAL DAMAGES CAUSED BY THE USE, MISUSE OR INABILITY TO USE THE EQUIPMENT, REGARDLESS OF THE LEGAL THEORY ON WHICH THE CLAIM IS BASED, AND EVEN IF CANON USA HAS BEEN ADVISED OF THE POSSIBILITY OF SUCH DAMAGES. NOR SHALL RECOVERY OF ANY KIND AGAINST CANON USA BE GREATER THAN THE PURCHASE PRICE OF THE EQUIPMENT SOLD BY CANON USA AND CAUSING THE ALLEGED DAMAGE. WITHOUT LIMITING THE FOREGOING, YOU ASSUME ALL RISK AND LIABILITY FOR LOSS, DAMAGE OR INJURY TO YOU AND YOUR PROPERTY AND TO OTHERS AND THEIR PROPERTY ARISING OUT OF USE, MISUSE OR INABILITY TO USE THE EQUIPMENT NOT CAUSED DIRECTLY BY THE NEGLIGENCE OF CANON USA. (SOME STATES DO NOT ALLOW THE EXCLUSION OR LIMITATION OF INCIDENTAL OR CONSEQUENTIAL DAMAGES, SO THE ABOVE LIMITATION MAY NOT APPLY TO YOU). THIS WARRANTY SHALL NOT EXTEND TO ANYONE OTHER THAN THE ORIGINAL PURCHASER OF THIS EQUIPMENT OR THE PERSON FOR WHOM IT WAS PURCHASED AS A GIFT.

This warranty gives you specific legal rights, and you may also have other rights which vary from state to state. CANON U.S.A., INC.

CANON CONSUMER DIGITAL VIDEO EQUIPMENT LIMITED WARRANTY

The limited warranty set forth below is given by Canon Canada Inc. ("Canon Canada") with respect to Canon Consumer Digital Video Equipment (the "Equipment") purchased in Canada. This limited warranty is only effective upon presentation of a bill of sale or other proof of purchase for this Equipment to a Canon Service Facility when repairs are required.

The Equipment is warranted under normal, non-commercial, personal use, against defective materials or workmanship as follows:

Parts: Defective parts will be exchanged for new parts or, at Canon Canada's option, comparable rebuilt parts for a period of one year from the date of original purchase, except Video Heads which will be exchanged for a period of 3 months from the date of purchase.

Labour: For a period of one year from the date of original purchase, labour will be provided free of charge by our Canon Service Facilities in Canada.

This limited warranty covers all defects except where:

(a) The loss or damage to the product results from:

- i) accident, natural disaster, mishandling, abuse, neglect, unauthorized product modification or failure to follow instructions contained in the instruction manual;
- ii) the use of accessories, attachments, products, supplies, parts or devices with the Equipment that do not conform to Canon specifications or that cause abnormally frequent service problems;
- iii) repairs or services performed by any party other than a Canon Service Facility;
- iv) defective batteries or any exposure to water, sand or dirt;
- v) shipping (claim must be presented to the shipper);

(b) Any serial number on the video equipment is altered or removed.

(c) The Equipment is used for commercial, professional or industrial purposes.

This limited warranty does not cover the cabinet (exterior finish) of the Equipment, media, nor does it apply to Equipment purchased outside Canada.

If the Equipment contains a hard disk drive, Canon Canada recommends that data stored on that drive be duplicated or backed up to prevent its loss in the event of a failure or other malfunction of such drive.

TO OBTAIN WARRANTY SERVICE

Ship your Equipment in its original carton, box or equivalent, properly packed, fully insured with shipping charges prepaid, together with a copy of your bill of sale or other proof of purchase and a description of the problem to any of the Canon Service Facilities in Canada.

LIMITATIONS

Except as otherwise required by applicable legislation, this warranty is in lieu of all other warranties, conditions, guarantees or representations, express or implied, statutory or otherwise, relative to the Equipment, including implied warranties or conditions of merchantability or fitness for a particular purpose.

Canon Canada assumes no liability for special, consequential or incidental damages, loss or corruption of data including, without limitation, data stored on the hard disk drive of the Equipment or loss that may arise, whether on account of negligence or otherwise, from the use, misuse or inability to use the Equipment (including loss of profit, revenue, media or enjoyment) or from failure to conform to any express or implied warranties, conditions, guarantees or representations. Any recovery under this limited warranty shall not exceed the purchase price of the equipment. Canon Canada does not assume or authorize any other person to assume for Canon Canada any other liability with respect to this equipment.

This warranty does not extend to any person other than the original purchaser of the Equipment or the person for whom it was purchased as a gift and states your exclusive remedy.

NOTICE TO CONSUMER

If you plan to take important videos or if the product has not been used for some time, please check all functions with the instruction book before using it.



USA	<p>CANON U.S.A., INC. NEW JERSEY OFFICE 100 Jamesburg Road, Jamesburg, NJ 08831 USA</p> <p>CANON U.S.A., INC. CHICAGO OFFICE 100 Park Blvd., Itasca, IL 60143 USA</p> <p>CANON U.S.A., INC. LOS ANGELES OFFICE 15955 Alton Parkway, Irvine, CA 92618 USA</p> <p>CANON U.S.A., INC. HONOLULU OFFICE 210 Ward Avenue, Suite 200, Honolulu, HI 96814 USA</p> <ul style="list-style-type: none">❖ If you have any questions, call the Canon U.S.A. Information Center toll-free at 1-800-828-4040 (USA only).
CANADA	<p>CANON CANADA INC. 6390 Dixie Road, Mississauga, ON L5T 1P7</p> <p>CANON CANADA INC. CALGARY 2828 16th Street NE, Calgary, AB T2E 7K7</p> <p>CANON CANADA INC. MONTREAL 8801 Route Transcanadienne, Saint-Laurent, QC H4S 1Z6</p> <ul style="list-style-type: none">❖ If you have any questions, call the Canon Canada Information Center toll free (in Canada only) at 1-800-OK-CANON (1-800-652-2666).❖ Si vous avez des questions, veuillez téléphoner 1-800-OK-CANON (1-800-652-2666, sans frais au Canada seulement).
MÉXICO	<p>CANON MEXICANA, S DE RL DE CV Blvd. Manuel Ávila Camacho No. 138, Piso 17 Col. Lomas de Chapultepec, C.P. 11000 México, D.F., México</p> <p>CANON U.S.A., INC. NEW JERSEY OFFICE 100 Jamesburg Road, Jamesburg, NJ 08831 USA</p>
CENTRO Y SURAMÉRICA	<p>CANON LATIN AMERICA, INC. 703 Waterford Way, Suite 400, Miami, FL 33126 USA</p>
ASIA	<p>CANON HONGKONG COMPANY LTD. 19/F, The Metropolis Tower, 10 Metropolis Drive, Hungghom, Kowloon, Hong Kong Tel: +852 3191 2333, Fax: +852 2428 3963</p>

- For support concerning the supplied PIXELA applications, please call PIXELA customer support (details in the 'PIXELA Applications' Installation Guide).
- Pour le support technique concernant les logiciels PIXELA fournis, veuillez appeler le service clientèle de PIXELA (les détails se trouvent dans le Guide d'installation 'PIXELA Applications').
- Para soporte relacionado las aplicaciones de PIXELA suministradas, llame al centro de atención al cliente de PIXELA (vea los detalles en la Guía de instalación 'PIXELA Applications').